

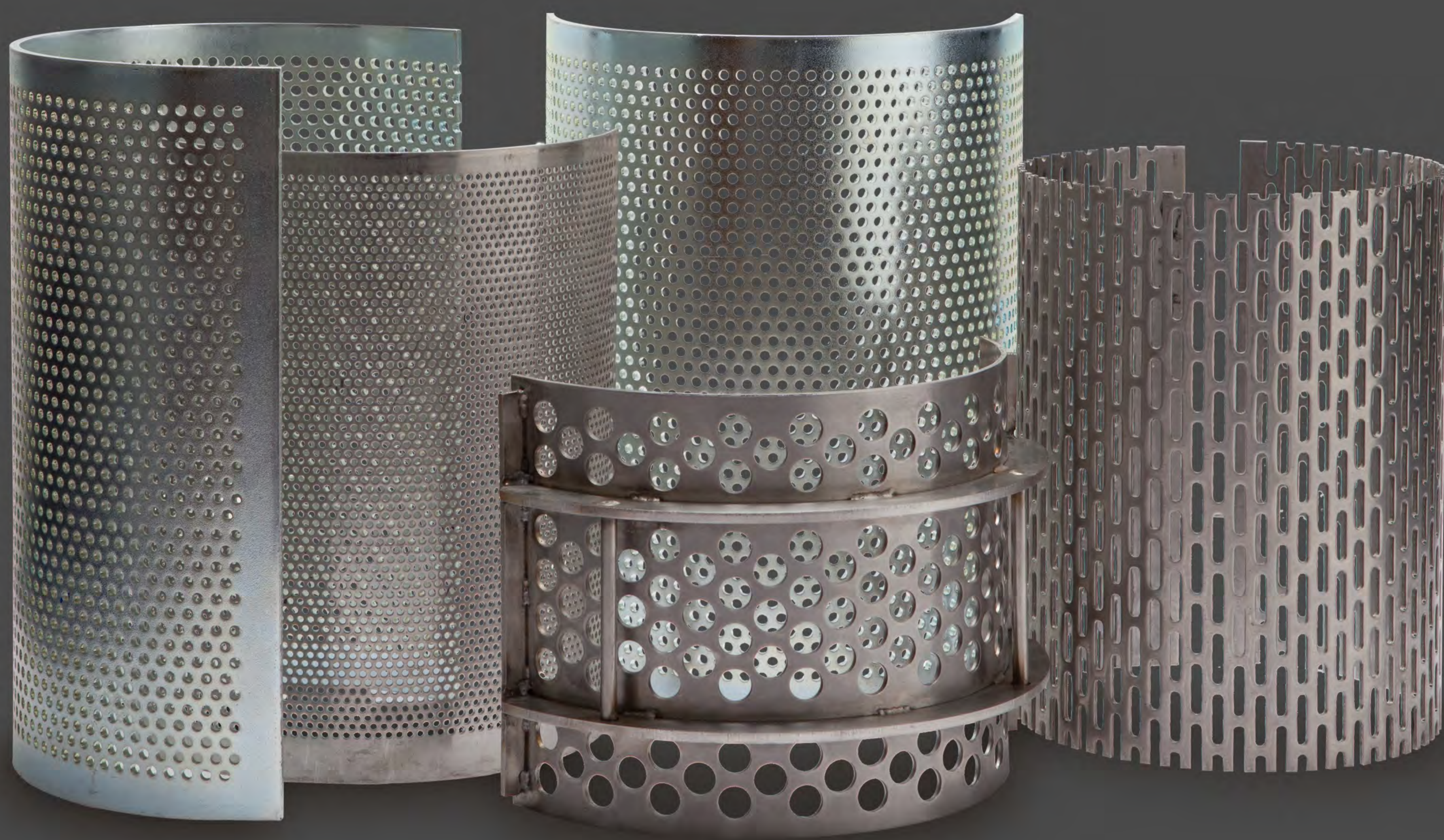

PERFOM



PERFORIRANI LIMOSI I PROIZVODI
PERFORATION & METAL FORMING

www.perfom.rs



PROIZVODI

- Perforirani limovi (plastika, guma...)
- Orebreni limovi
- Perforirana sita i delovi
- Precizni delovi za industriju
- Perforirane maske za zvučnike
- Perforirani podovi
- Protivklizna perforacija - limovi i gazišta
- Perforirani navozi i delovi za autotransport
- Protivklizna gazišta - profili
- Protivklizni stepenici
- Protivklizni spiralni stepenici
- Protivklizni stepenici za merdevine
- Rešetkasta varena gazišta
- Plehovi, tepsije i kolica za pekare
- Korpe za otpatke
- Nosači kablova
- Limene stalaže i panoi
- Proizvodi po zahtevu

PRODUCTS

- Perforated metal sheets (plastic, rubber...)
- Embossed metal sheets
- Perforated metal screens and parts
- Industry supply - accurate metal forming
- Perforated speaker grilles
- Perforated floors
- Antiskid perforation - sheets and gratings
- Perforated parts for car carriers and trailers
- Antiskid gratings - profiles
- Antiskid stairway steps
- Antiskid spiral staircases
- Antiskid rungs for ladders
- Steel welded gratings
- Baking trays, tools and trolley
- Wastepaper baskets
- Cable trays
- Metal racks and panels
- Custom products

■ Koreni naše delatnosti i razvoja datiraju od 1942. godine kada je Miloš R. Janković kao mlad i vešt majstor otvorio kovačko - kolarsku radnju i započeo sada već višedecenijsku porodičnu praksu i tradiciju obrade metala i limova. Sa višegodišnjim iskustvom, 1981. godine Marija i Janko Janković zajedno sa Milošem započinju proizvodnju perforiranih limova i srodnih proizvoda.

Od osnivanja pa do danas Perfom je svoj razvoj zasnovao na osnovnim načelima zdrave porodice i međuljudskih odnosa uz uvažavanje svih zaposlenih kao saradnika na istom zadatku. Spojili smo najsavremenije tehnologije i najbolje iz majstorske tradicije.

Perfom je danas tehnološki i kadrovski najopremljenije preduzeće u sektoru proizvodnje i prerade perforiranih limova kako u Srbiji tako i u regionu. To nas čini vodećim proizvođačem i prodavcem perforiranih limova i srodnih proizvoda.



■ The roots of our business and development dating back to 1942. when Milos R. Jankovic as a young and skillful blacksmith opened craftsmen workshop and started the now decades long family practice and tradition of metal processing and production. In 1981. Marija and Janko Jankovic together with Milos start manufacturing of perforated sheet metal and related products.

From its foundation until today Perfom its development devised the basic principles of healthy family and interpersonal relationships with respect to all employees as associates on the same task. We've combined the latest technology and best craftsmen tradition.

Perfom today's technological and human resources best equipped company in the manufacturing and processing of perforated sheets in both Serbia and region. This makes us the leading manufacturer and seller of perforated sheet metal and related products.



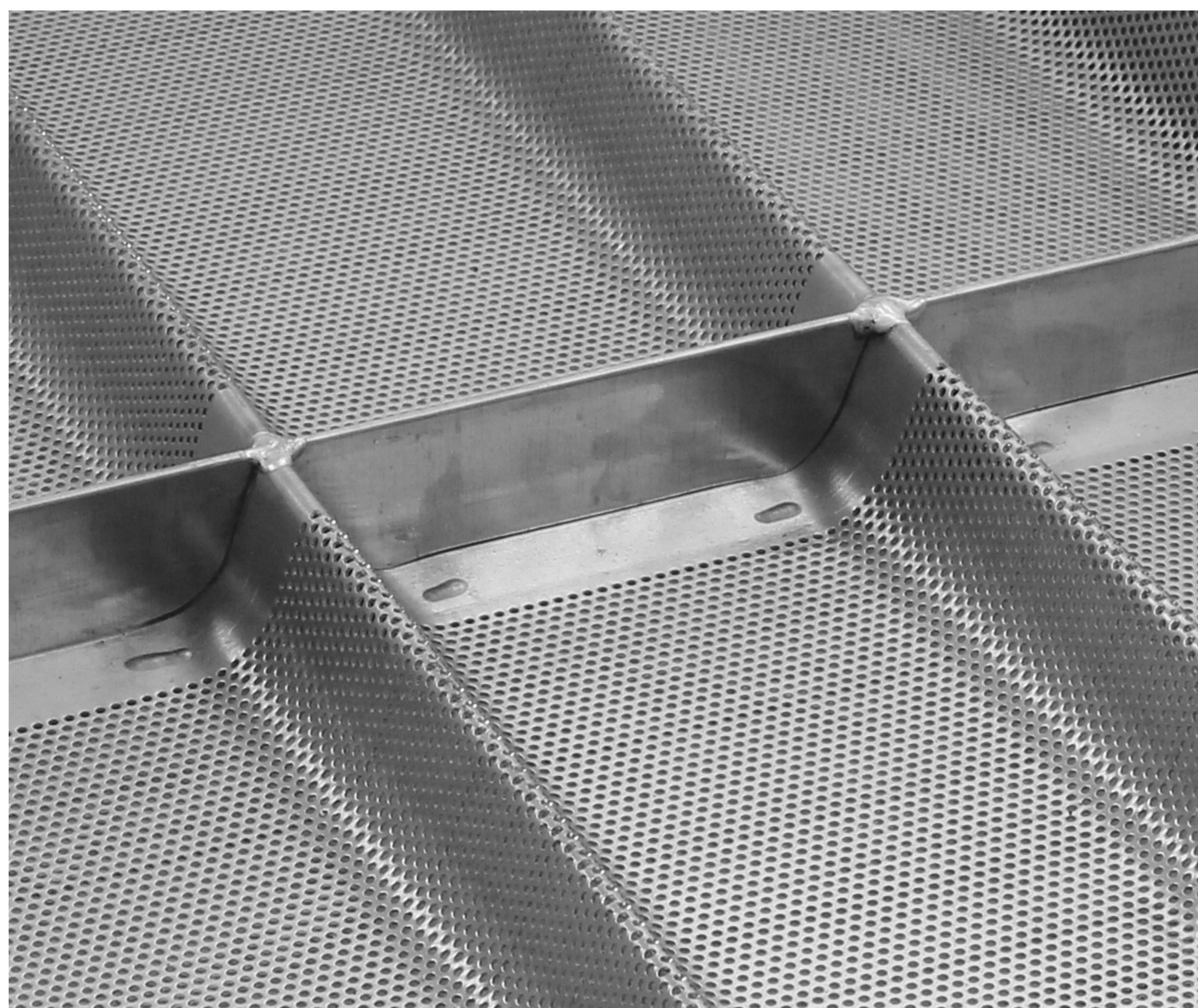
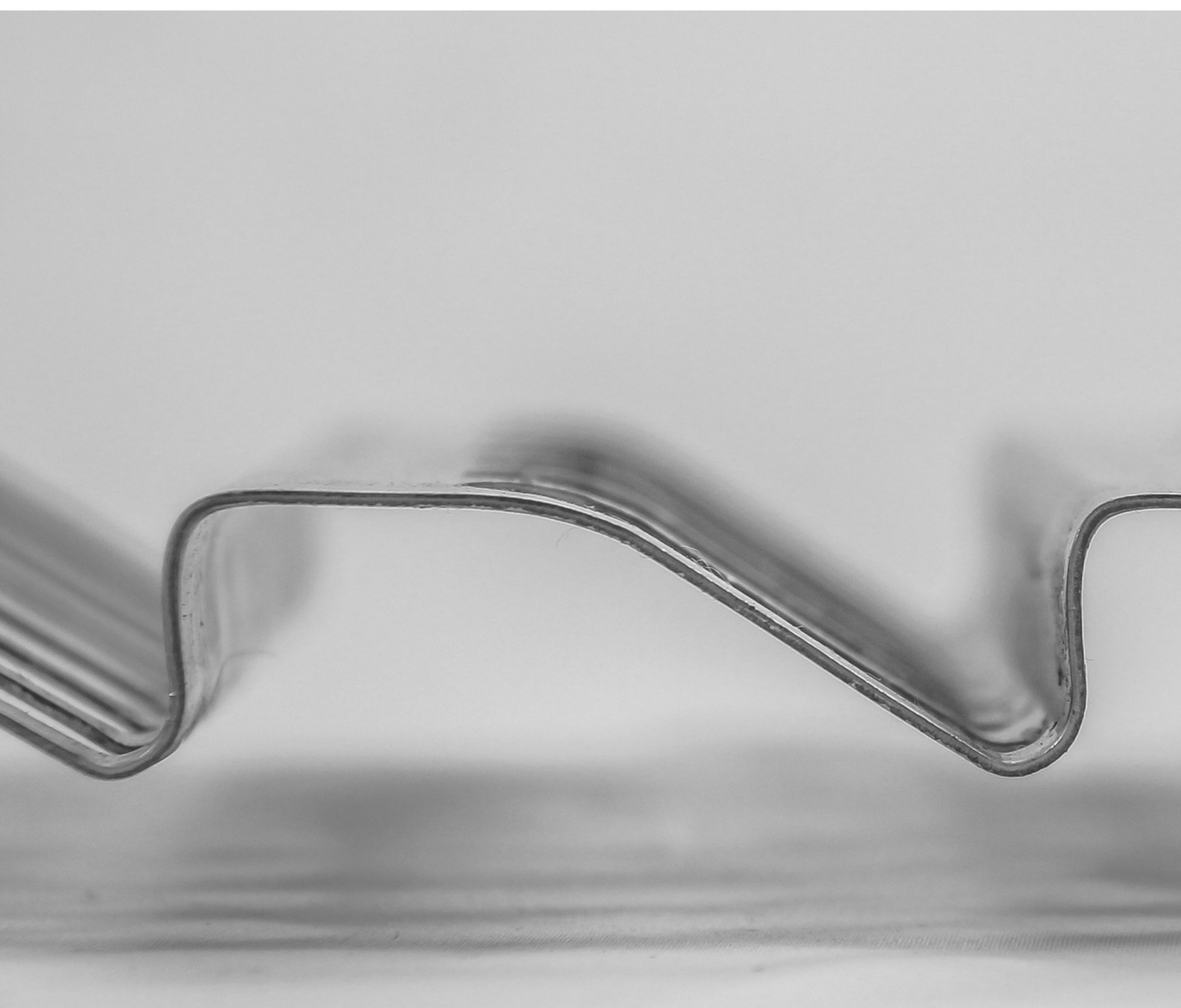
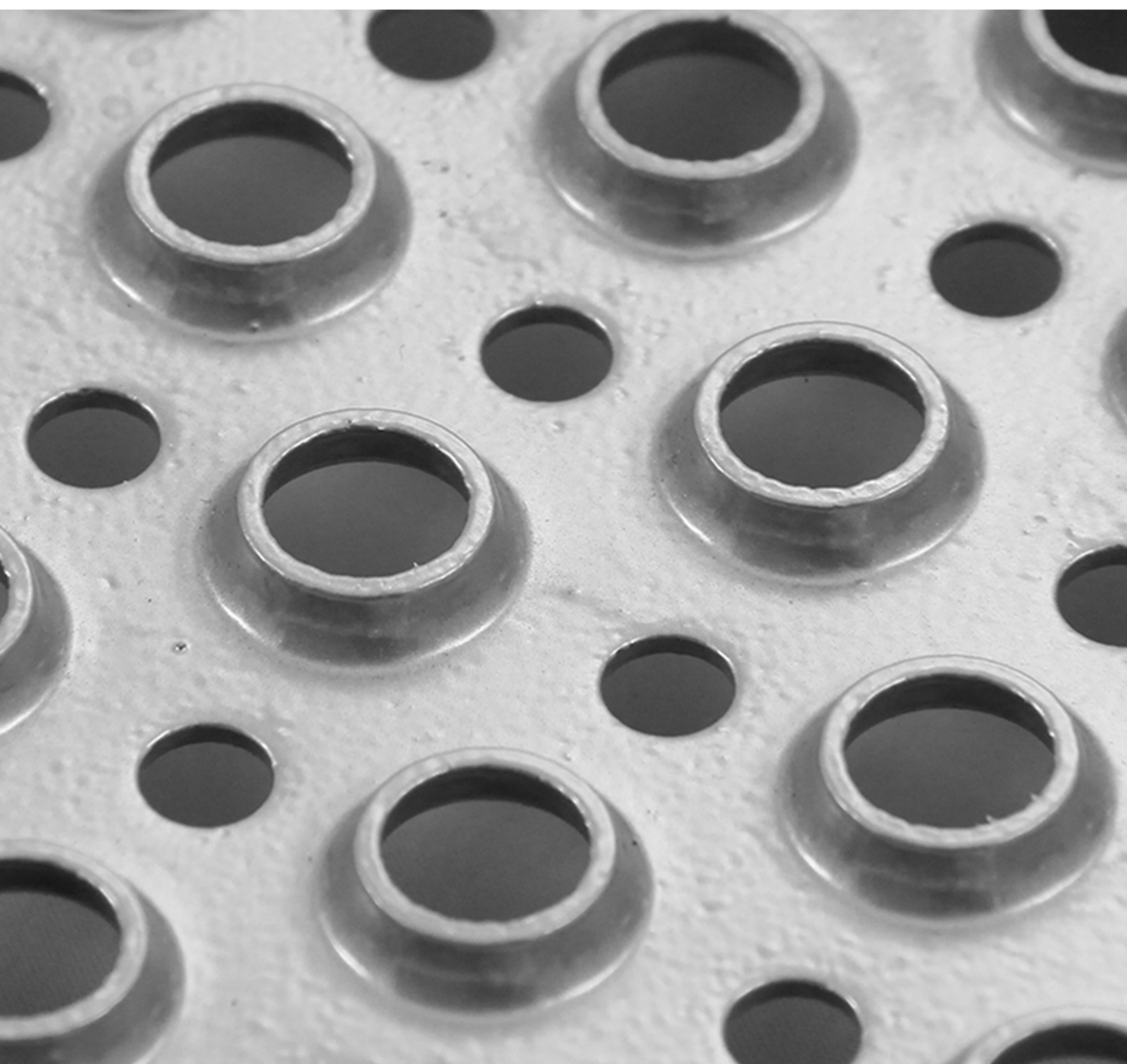
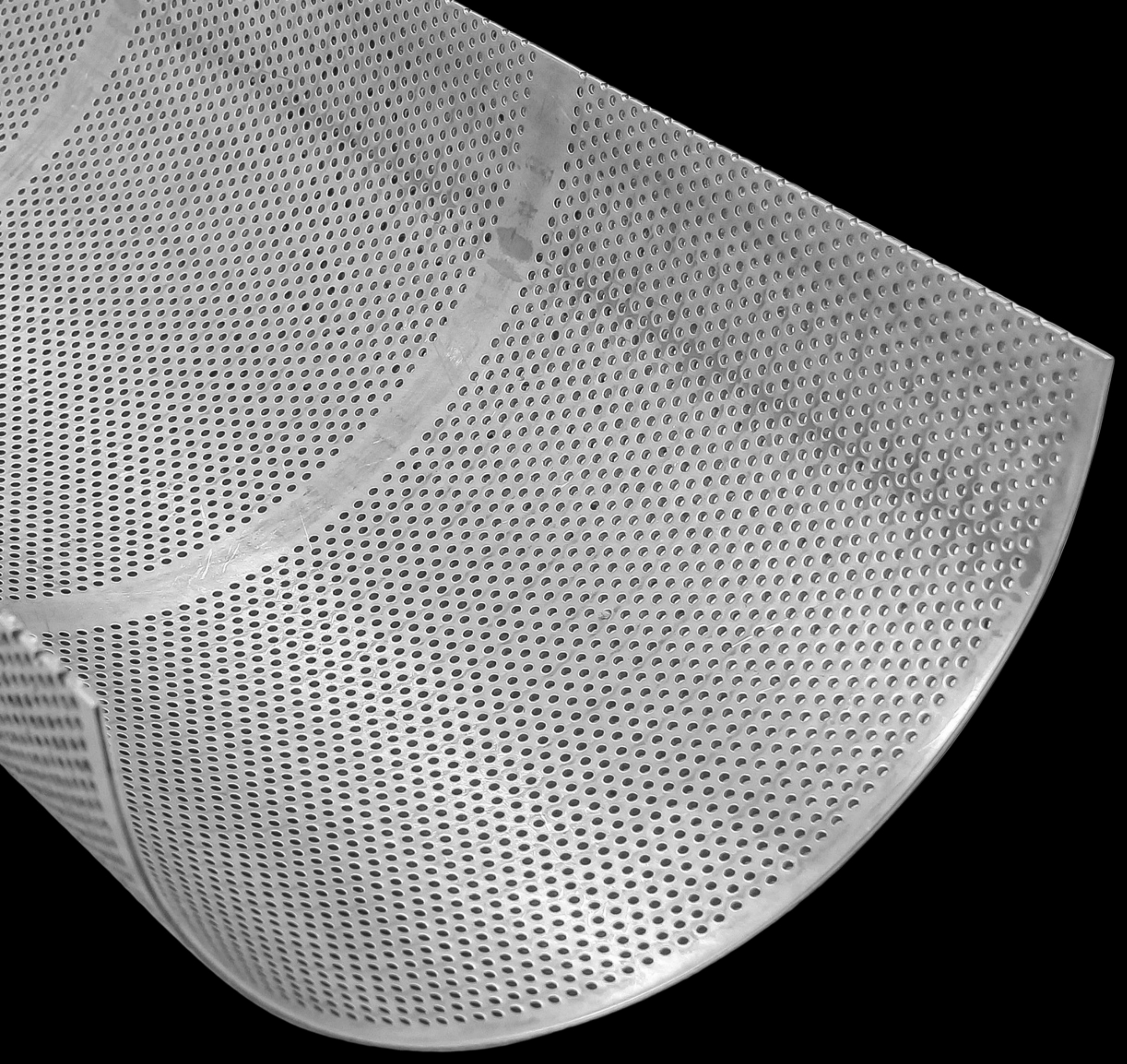

PERFORIRANI LIMOVI

PERFORATED METAL SHEETS

STANDARDNE PERFORACIJE
STANDARD PERFORATION

SPECIJALNE PERFORACIJE
SPECIAL PERFORATION

DEKORATIVNE PERFORACIJE
DECORATIVE PERFORATION

materijal material	čelik, prohrom, pocinkovani, aluminium, bakar, mesing, alubond, plastika... steel, stainless steel, galvanized, aluminum, copper, brass, alubond, plastik...
debljina thickness	max 12mm *veće debljine na upit / thicker plate on request
dimenzija dimension	max. 1500x3000mm *veće dimenzije na upit / larger dimension on request
otvori perforacije perforation	okrugli, kvadratni, duguljasti, heksagonalni, dekorativni, specijalni, po zahtevu round, square, oblog, hexagonal, decorative, special, on request
količine quantity	nema min. količine, prototipovi, male, srednje, velike serije, izrada po zahtevu no min. quantity, prototype, small, medium, big quantity, custom production
napomena notice	proizvodnja prema DIN-ISO standardima production according to DIN-ISO standards

OREBRENI LIMOVI

EMBOSSSED METAL SHEETS

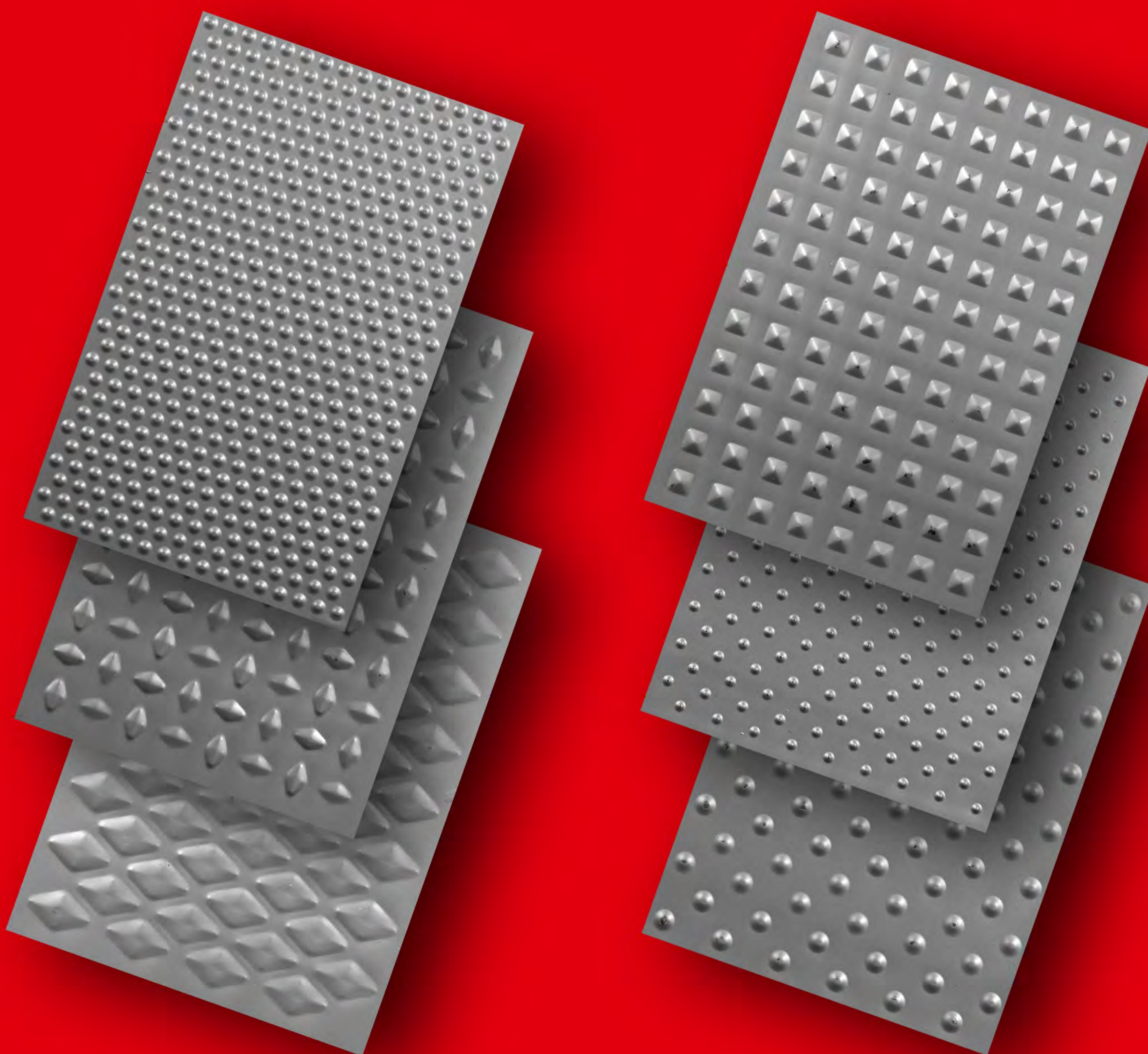

materijal material	čelik,prohrom,pocinkovani,aluminium,bakar,mesing steel,stainless steel,galvanized,aluminum,copper,brass
debljina thickness	max 5mm *zavisi od modela orebrenja / depend of embossing model
dimenzija dimension	max. 1500x3000mm *veće dimenzije na upit / larger dimension on request
model orebrenja embossing model	prema katalogu orebreni limovi na www.perfom.rs according to catalogue - download from www.perfom.rs
količine quantity	nema min.količine,prototipovi,male,srednje,velike serije,izrada po zahtevu no min.quantity,prototype,small,medium,big quantity,custom production
napomena notice	proizvodnja prema DIN-ISO stanardima production according to DIN-ISO standards

PERFORIRANA SITA I DELOVI

PERFORATED METAL SCREENS AND PARTS

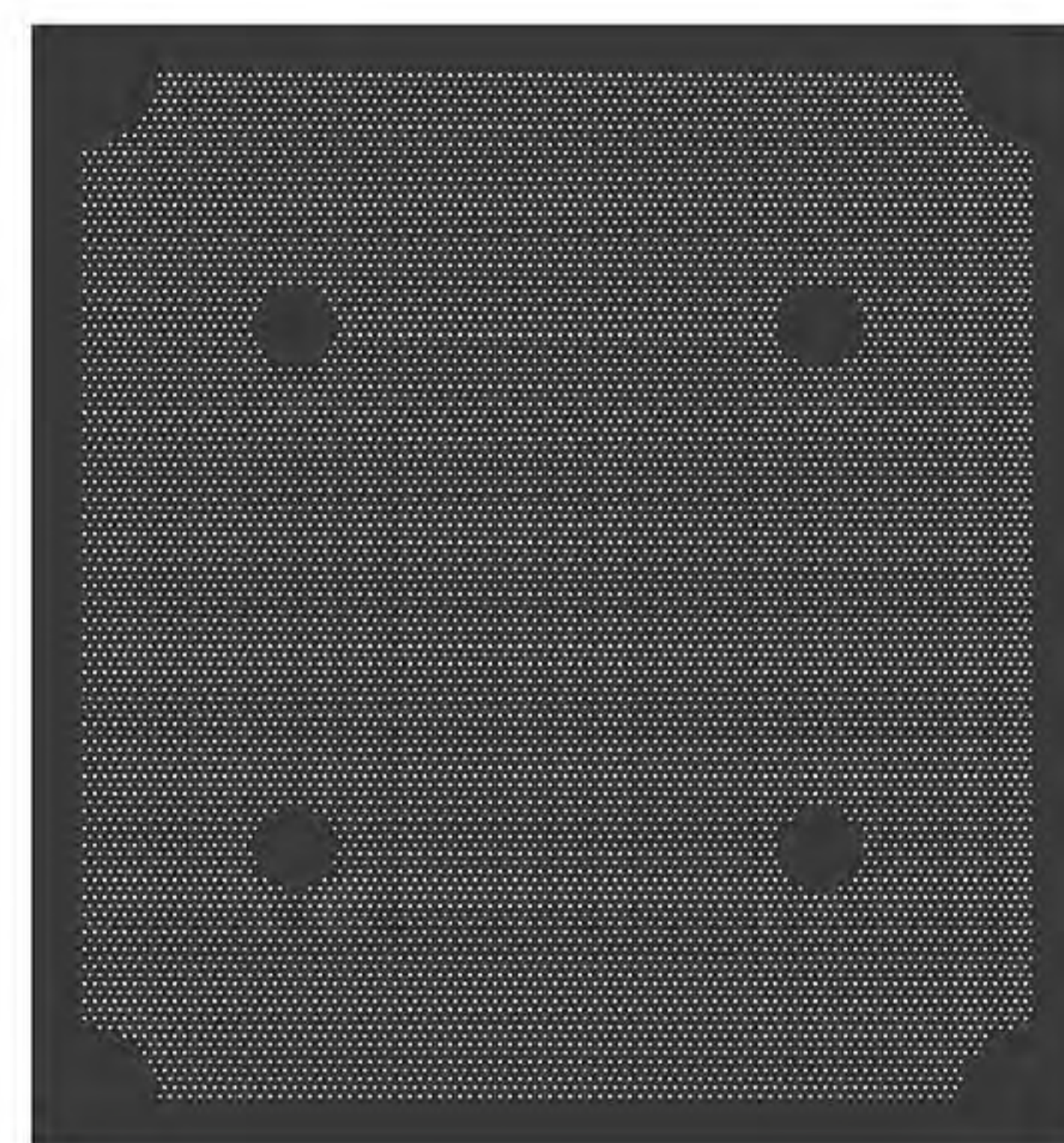
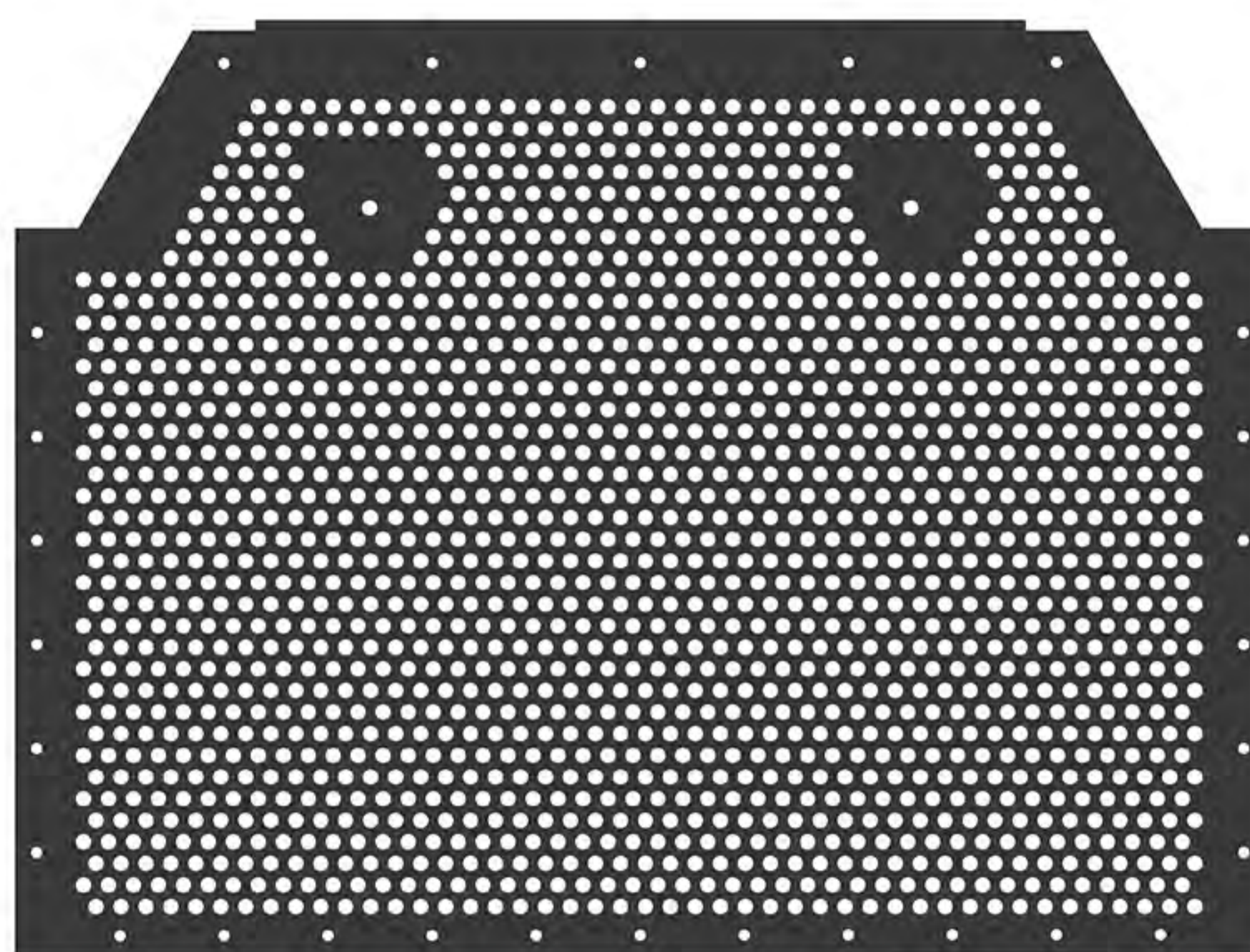
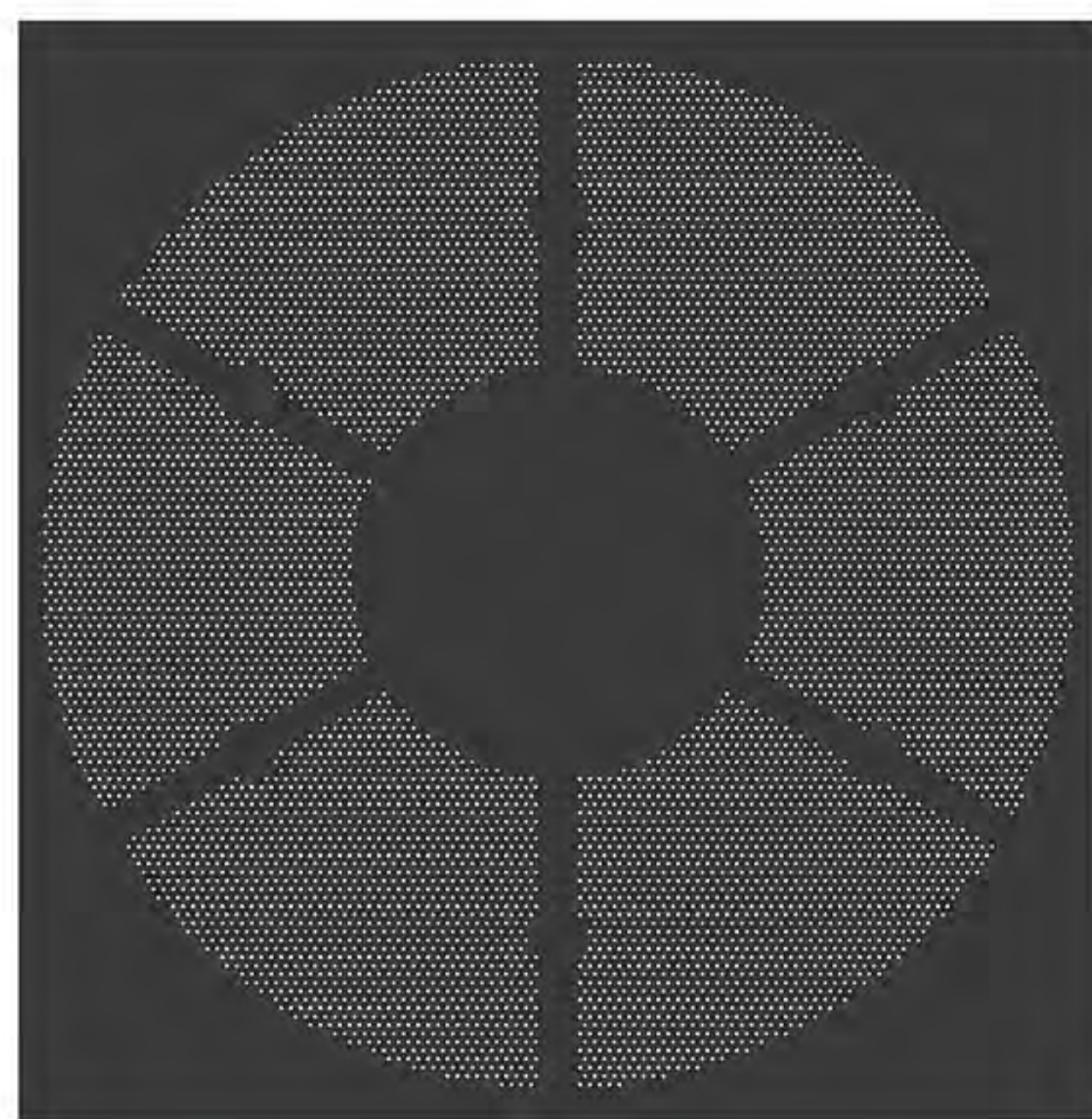
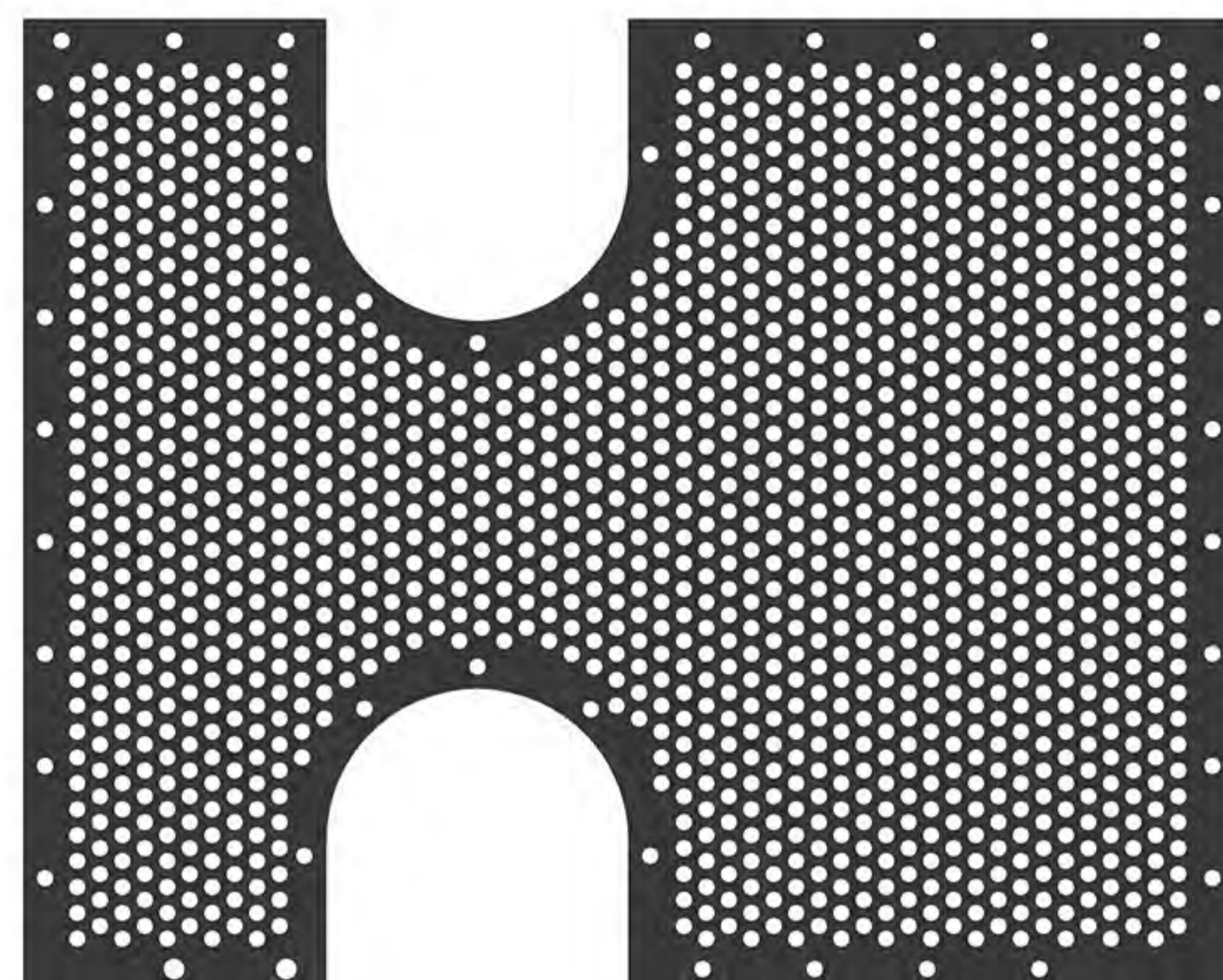
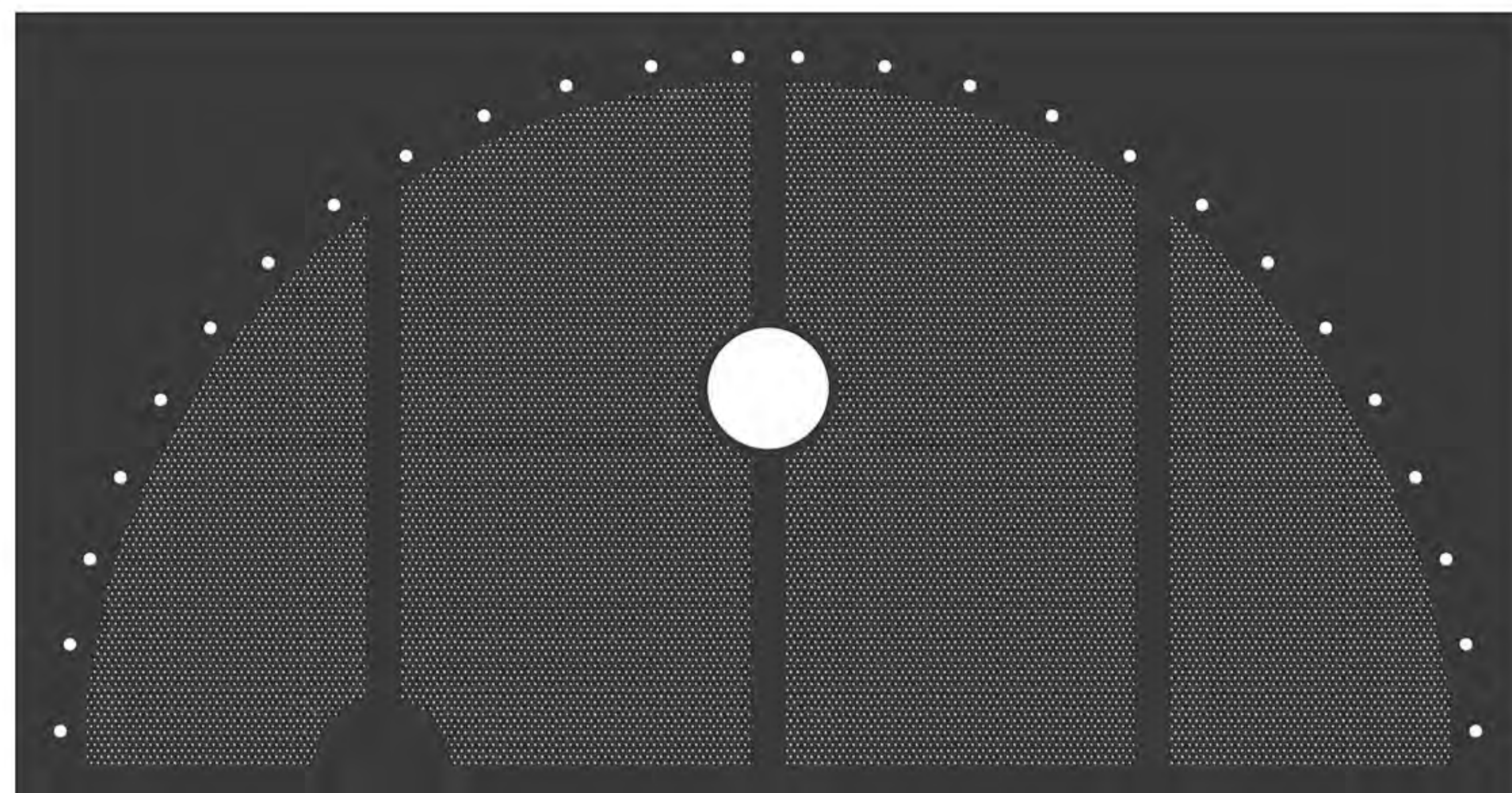

materijal material	čelik,prohrom,pocinkovani,aluminium,bakar,mesing,domex,mangan... steel,stainless steel,galvanized,aluminum,copper,brass,domex,manganese...
debljina thickness	max 12mm *veće debljine na upit / thicker plate on request
dimenzija dimension	prema zahtevu kupca according to customer request
otvori perforacije perforation	okrugli,kvadratni,duguljasti,heksagonalni,dekorativni,specijalni,po zahtevu round,square,oblog,hexagonal,decorative,special,on request
dodatne operacije additional operation	sečenje,savijanje,rolovanje,tig-mig zavarivanje cutting ,bending,rolling,tig-mig welding
količine quantity	nema min.količine,prototipovi,male,srednje,velike serije,izrada po zahtevu no min.quantity,prototype,small,medium,big quantity,custom production
modeli sita screen models	ravna,segmentna,polukružna,kružna,vibro sita flat,segment,revolving,vibration screens
napomena notice	proizvodnja prema DIN-ISO standardima production according to DIN-ISO standards



PERFORIRANA SITA I DELOVI

PERFORATED METAL SCREENS AND PARTS



PERFORIRANA SITA I DELOVI

PERFORATED METAL SCREENS AND PARTS

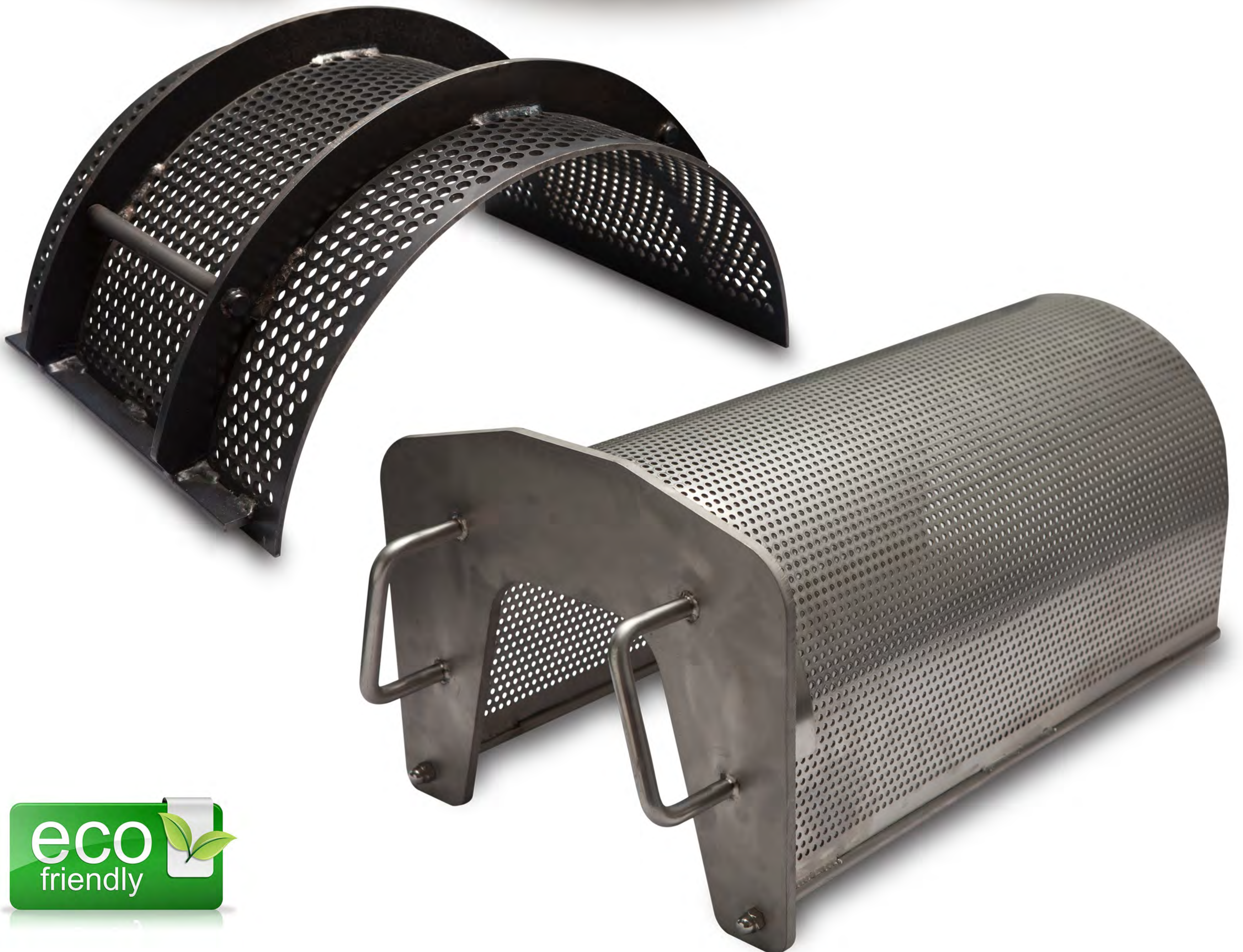

PRECIZNI DELOVI ZA INDUSTRIJU

INDUSTRY SUPPLY - ACCURATE METAL FORMING



- Preciznost.
- Konstantna kontrola kvaliteta u svim fazama procesa.
- Operacije perforacije, probijanja, utiskivanja, savijanja, presovanja, nitovanja, zakivanja matica, sklapanja...



- Accurate in production.
- Permanent quality control in all stages of process.
- Production include perforation, punching, embossing, countersunk, bending, stamping, rivetting, self clinching, assembly...

PERFORIRANE MASKE ZA ZVUČNIKE

PERFORATED SPEAKER GRILLES

- Razvoj i proizvodnja kroz neposrednu saradnju sa kupcem.
- Perforacija sa velikom otvorenom površinom, dugotrajnost i čvrstina za svakodnevnu upotrebu u svim uslovima, briga o detaljima za perfektan izgled finalnog proizvoda.
- Od ideje i crteža do finalnog proizvoda.

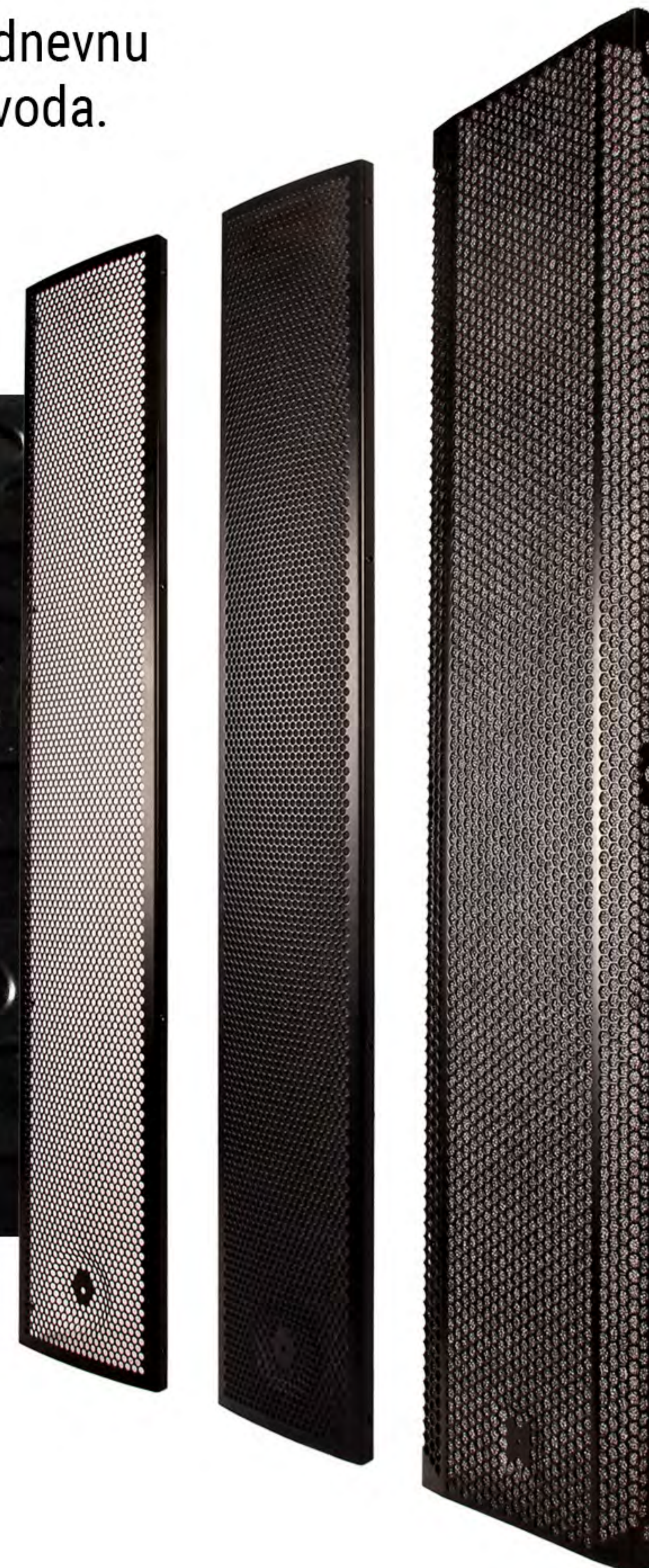
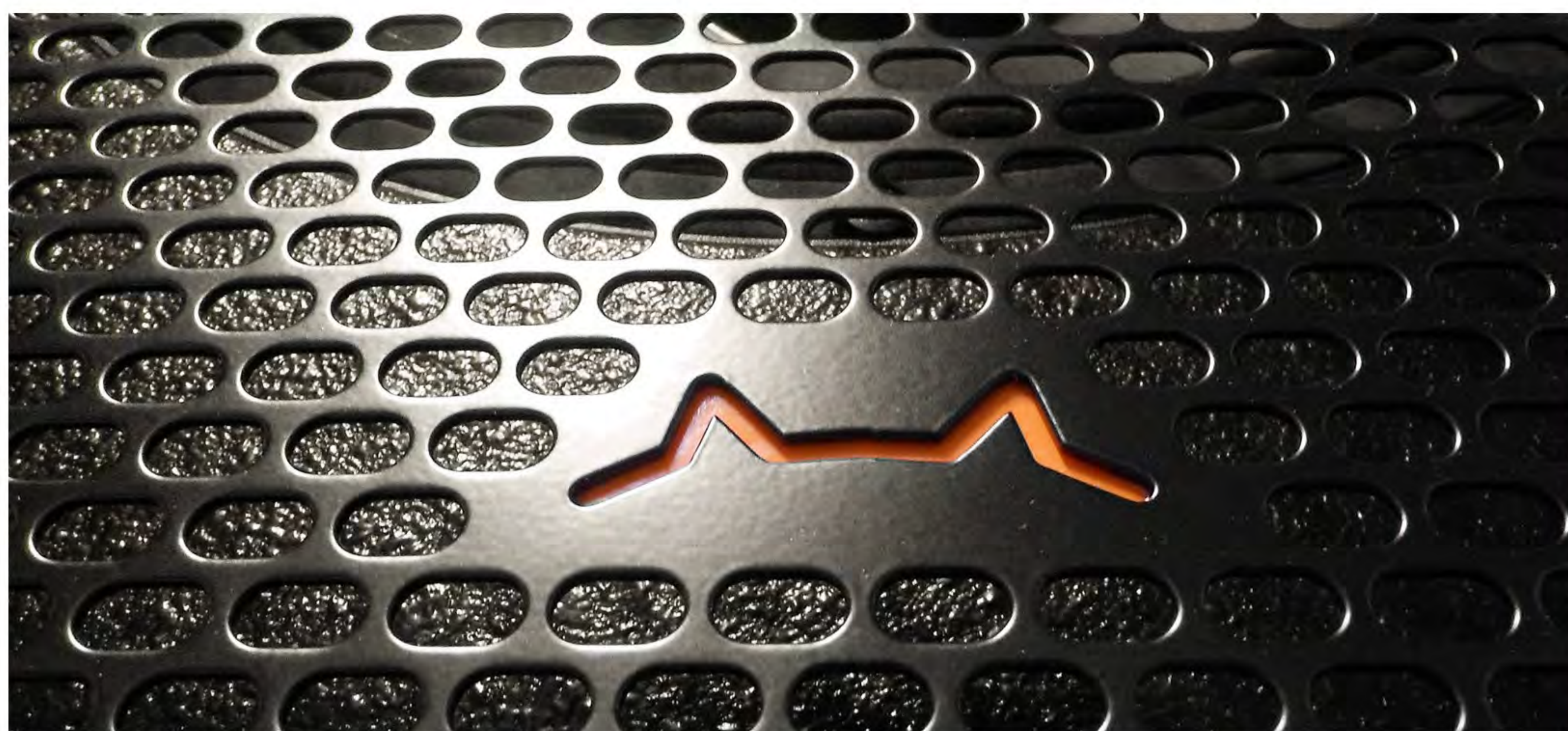

- Development and production in close collaboration with customer demands.
- High open area, durable in all application and condition, nice visual look.
- From idea and drawing to final product.

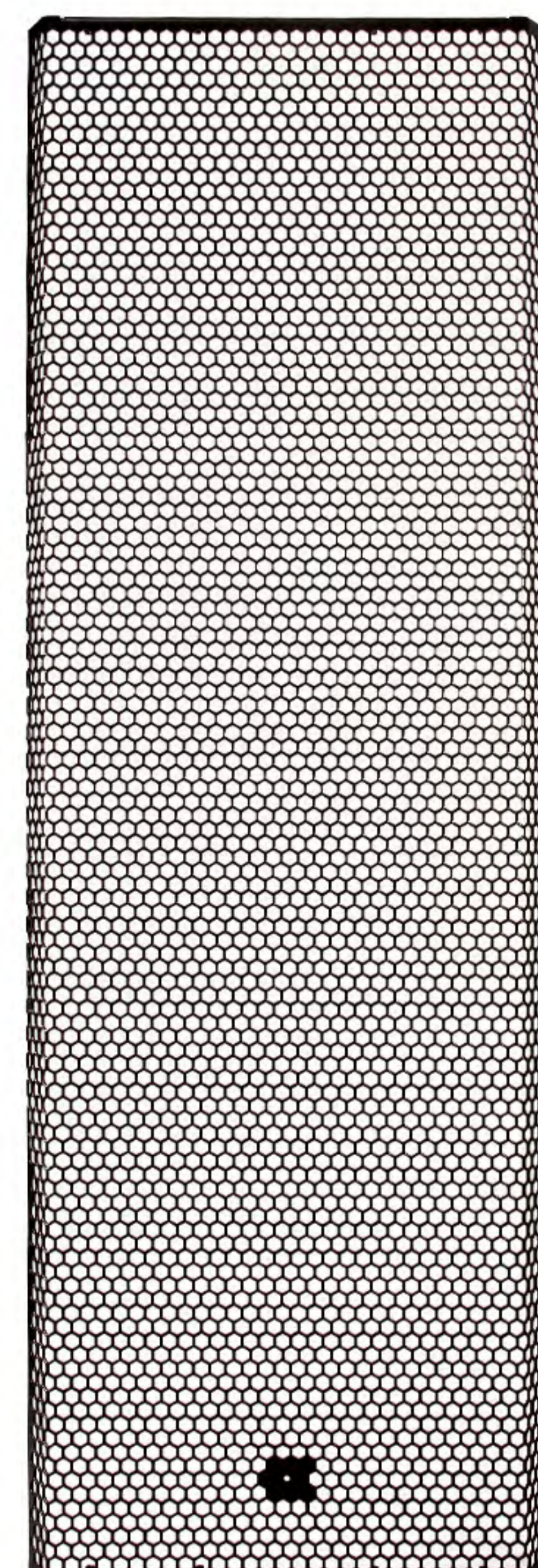
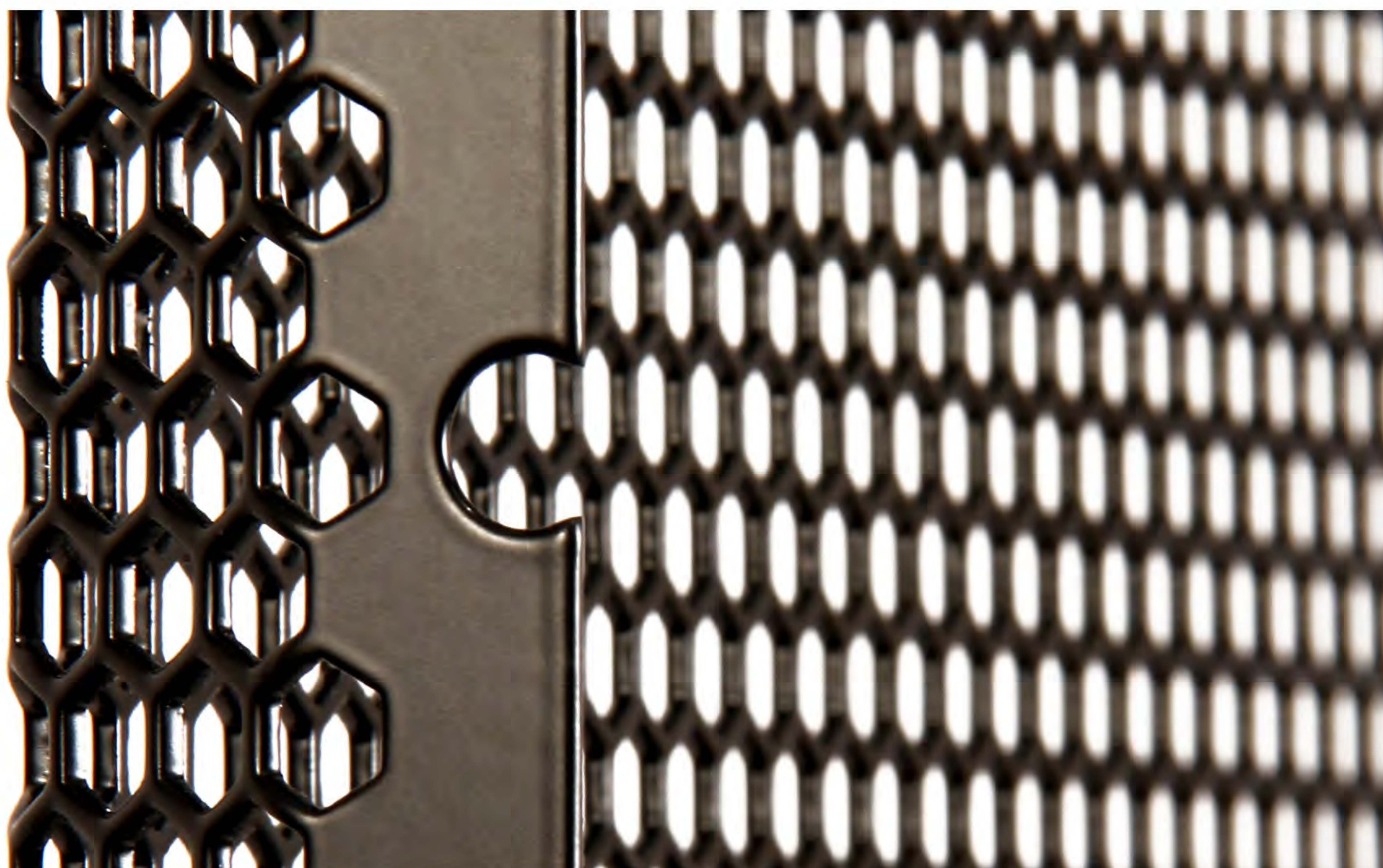

PERFORIRANI PODOVI PERFORATED FLOORS

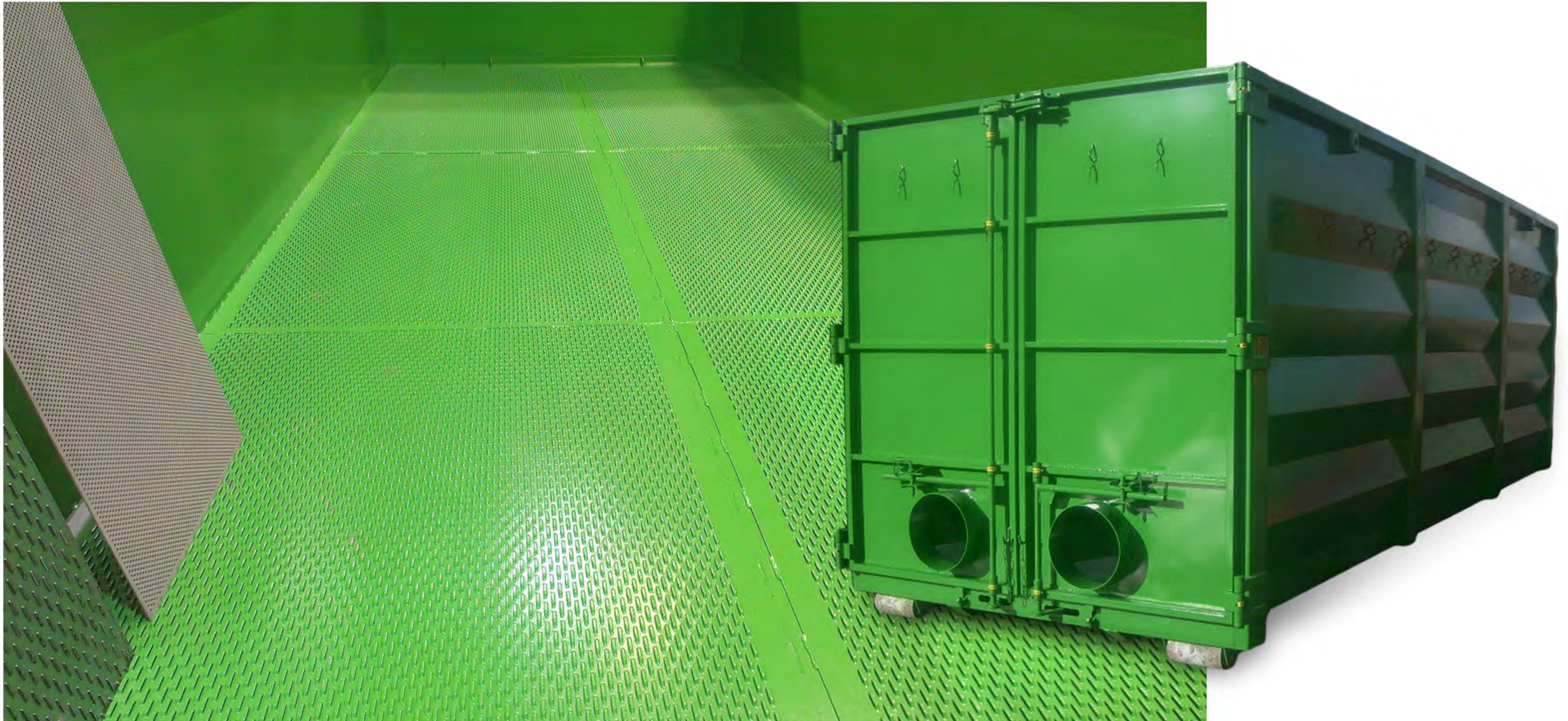

materijal material	najčešće čelik, prohrom, pocinkovani lim most common steel, stainless steel, galvanized metal sheet...
debljina thickness	max 5mm *veće debljine na upit / thicker plate on request
dimenzija dimension	prema zahtevu kupca according to customer request
otvori perforacije perforation	najčešće duguljasti poluizvučeni, džepasti, mostovni most common oblog, slot, brige slot
dodatne operacije additional operation	sečenje konture, savijanje, tig-mig zavarivanje cutting of contour, bending, tig-mig welding
količine quantity	nema min. količine, prototipovi, male, srednje, velike serije, izrada po zahtevu no min. quantity, prototype, small, medium, big quantity, custom production
napomena notice	proizvodnja prema DIN-ISO standardima production according to DIN-ISO standards

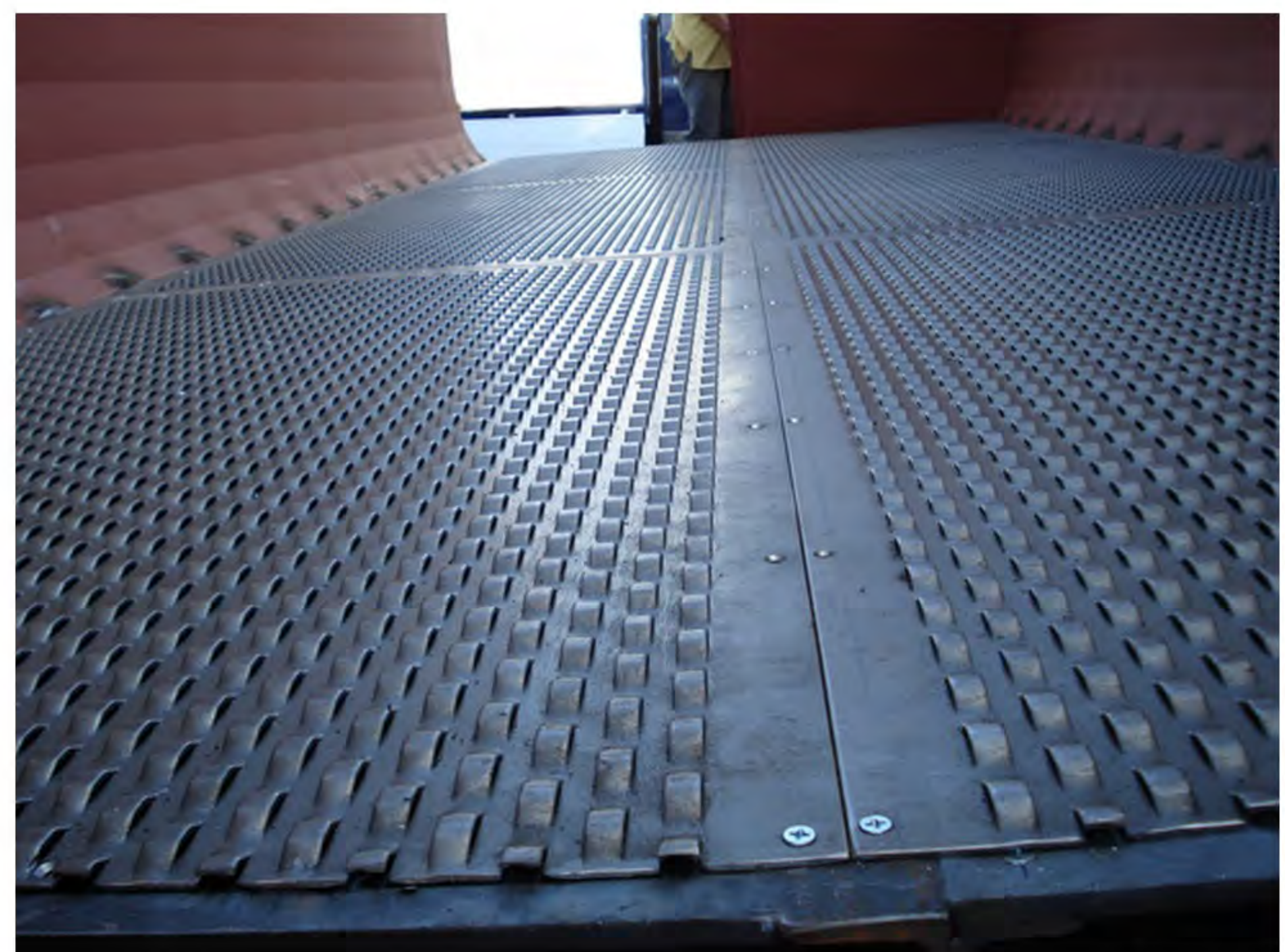

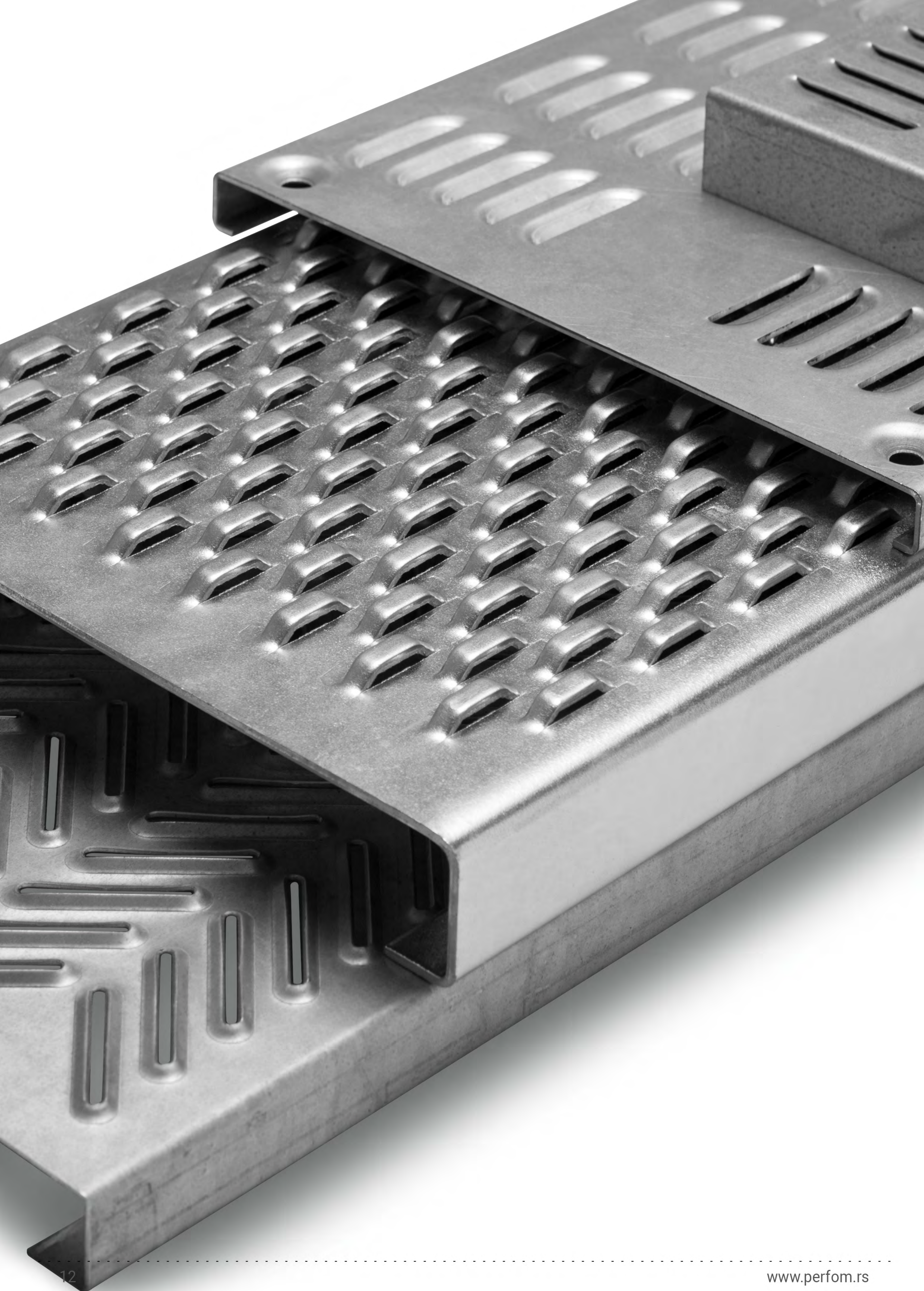

PROTIVKLIZNA PERFORACIJA - LIMOV I GAZIŠTA

ANTISKID PERFORATION - SHEETS AND GRATINGS

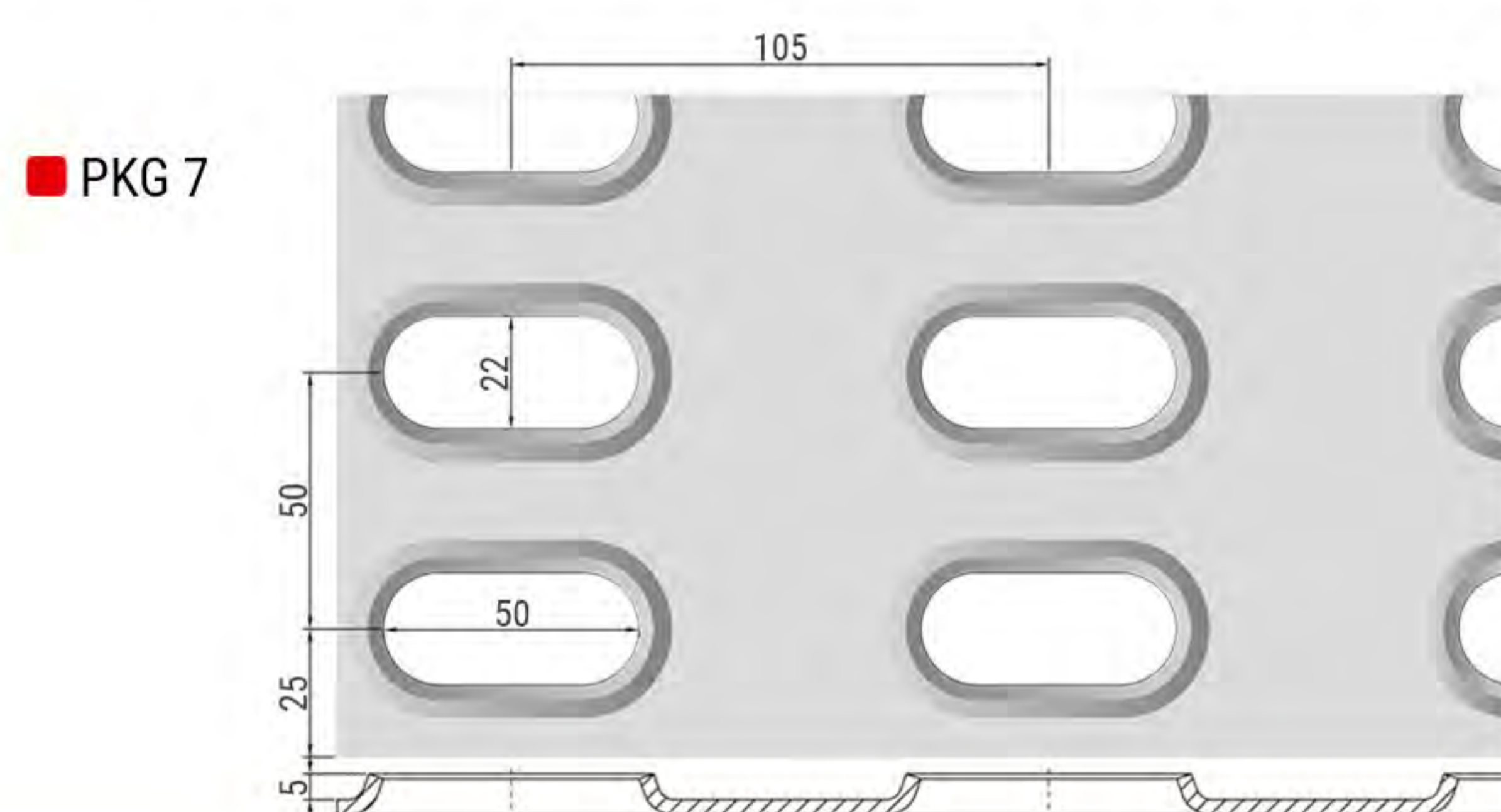
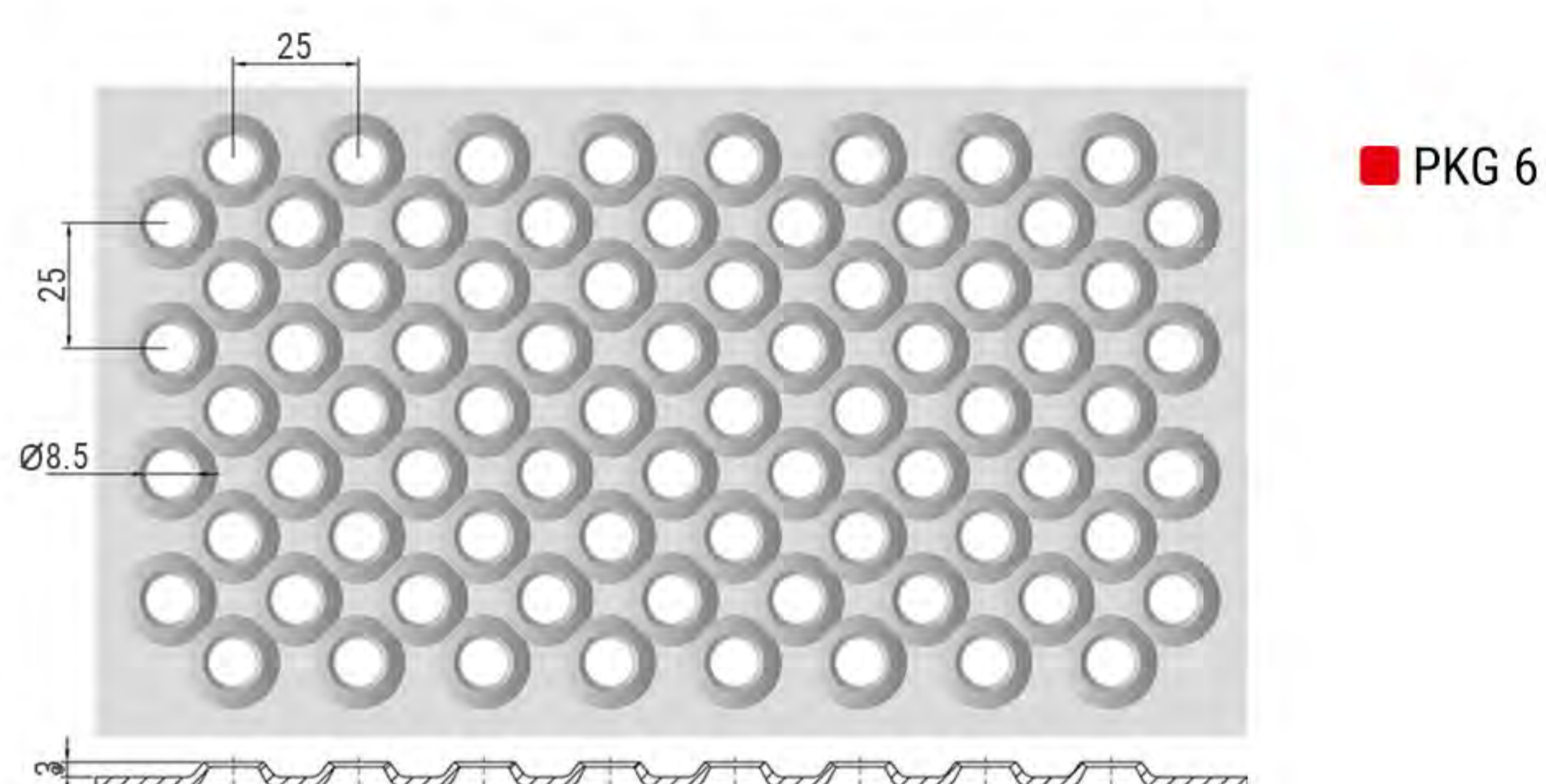
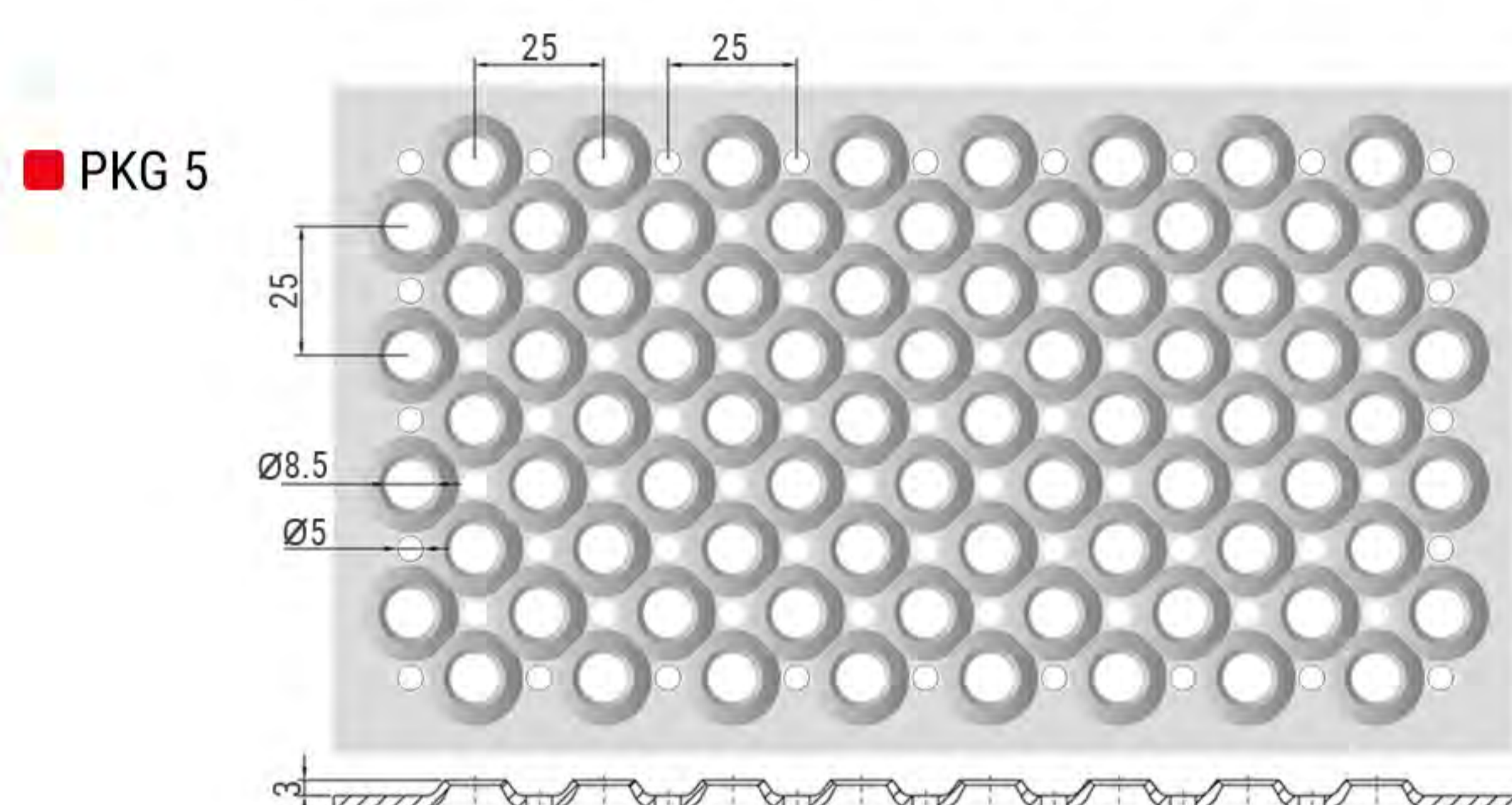
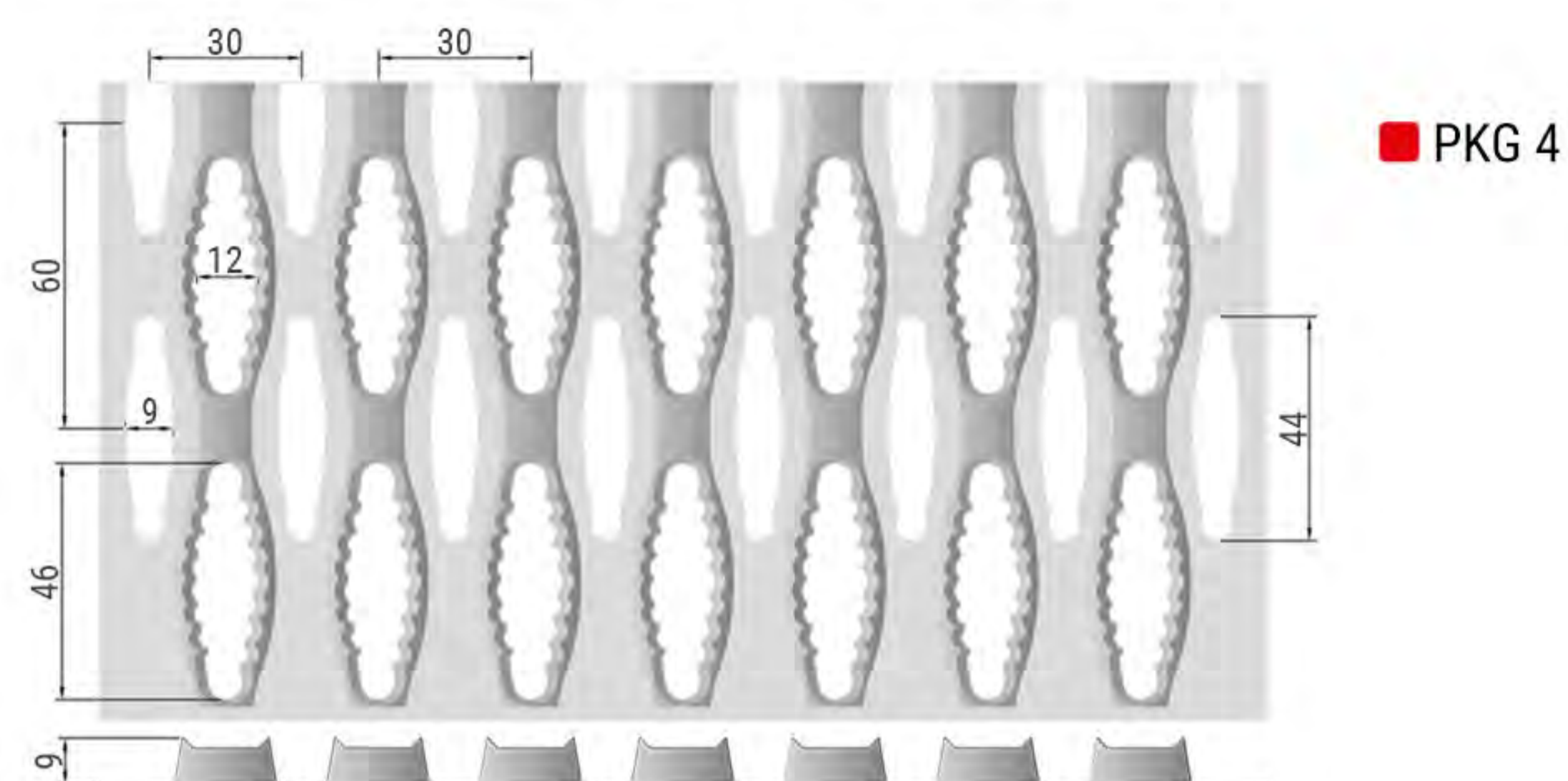
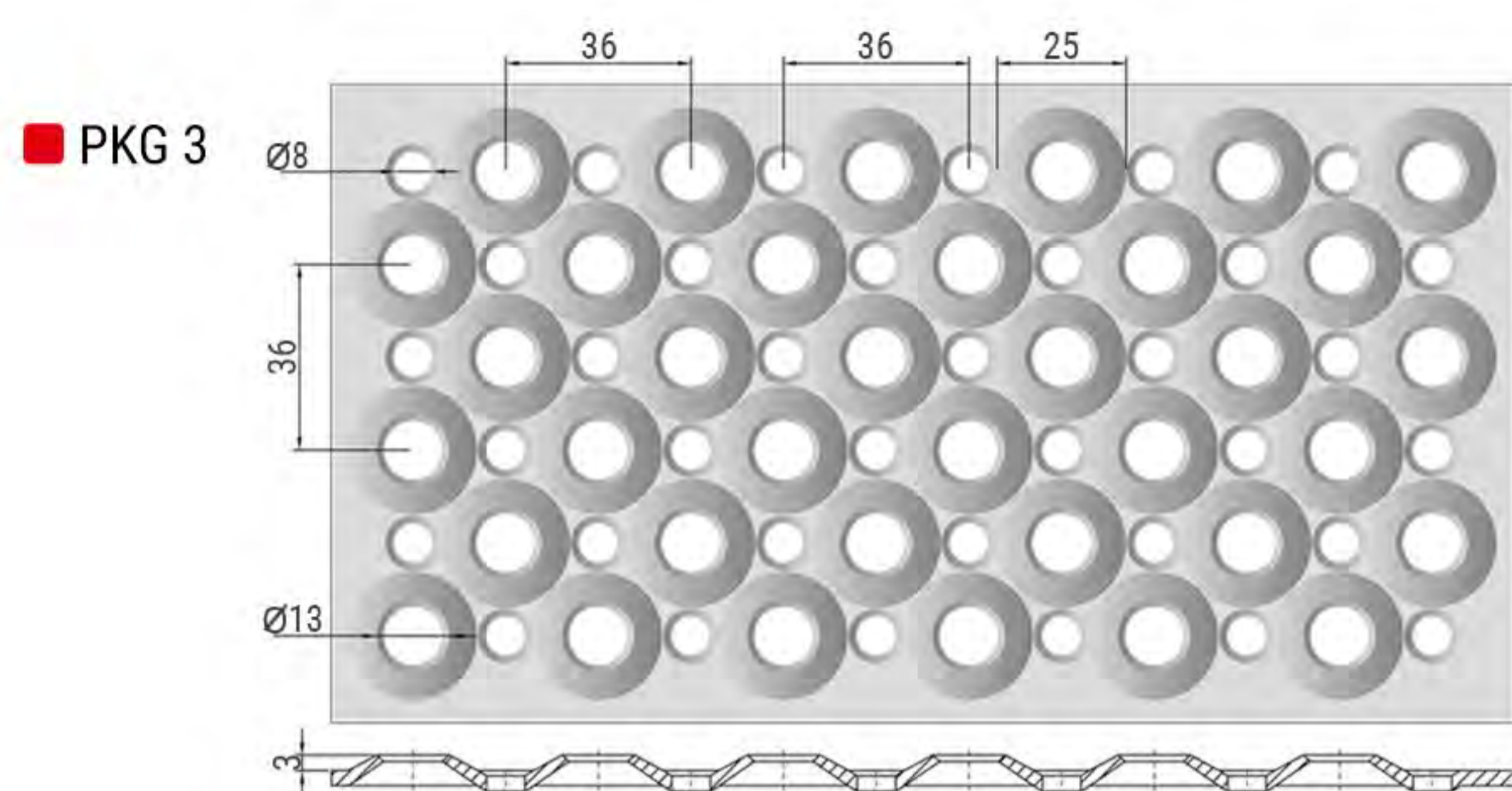
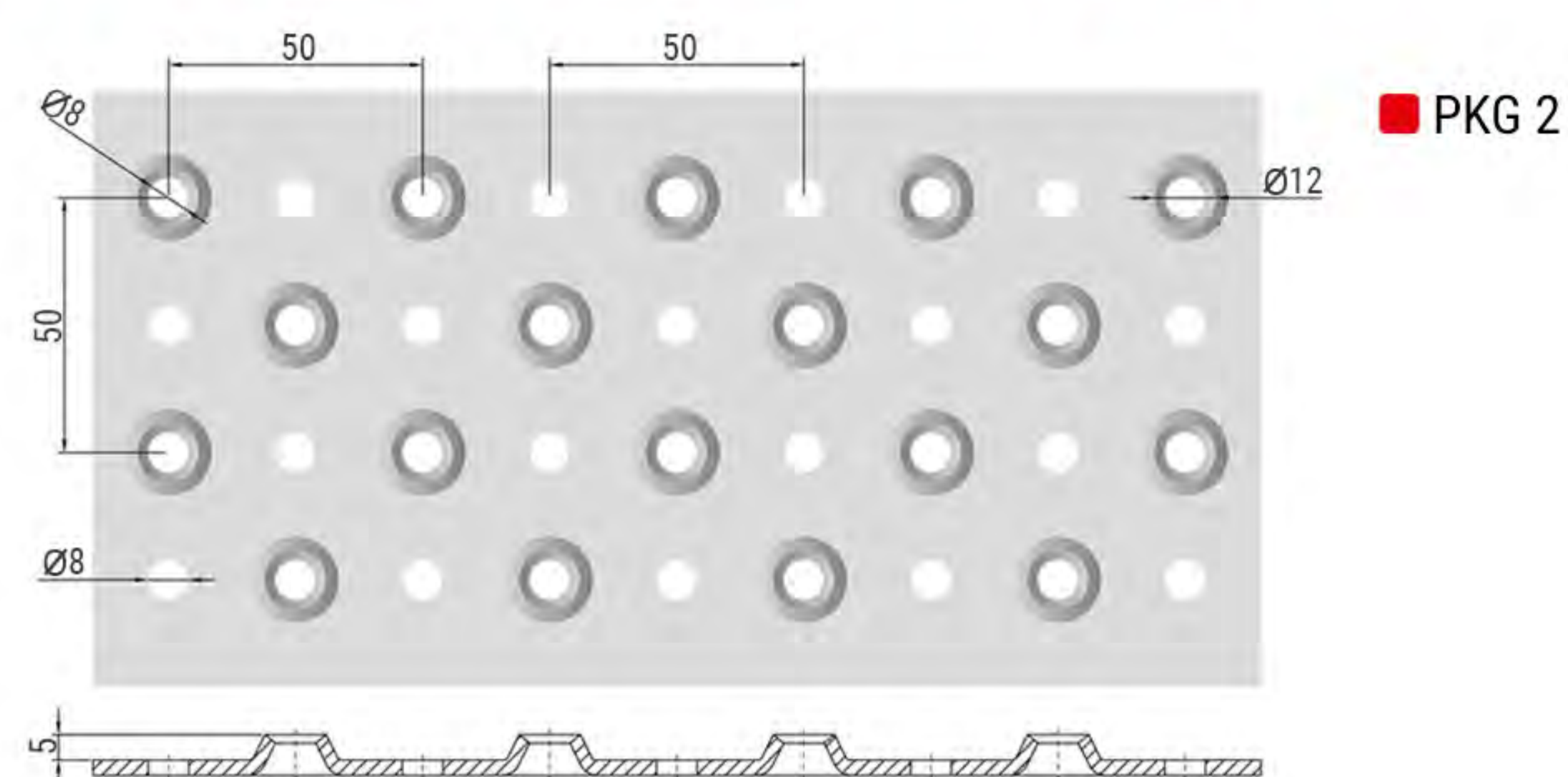
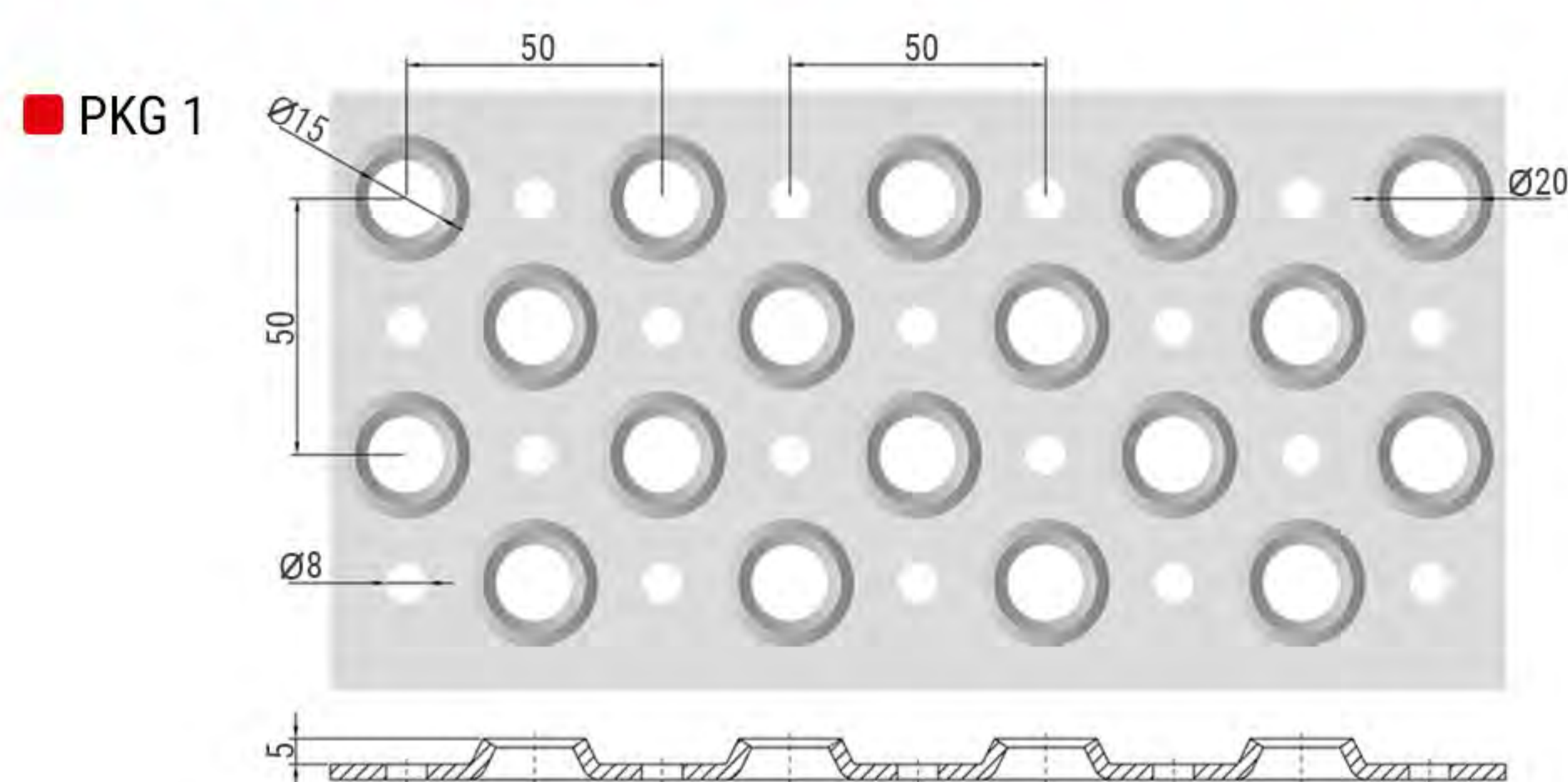

materijal material	čelik, prohrom, pocinkovani, aluminium... steel, stainless steel, galvanized, aluminum...
debljina thickness	max 5mm
dimenzija dimension	max. 1500x3000 limovi / profili i gazišta po zahtevu max. 1500x3000 metal sheet / profiles and grating according to request
otvori perforacije perforation	prema katalogu protivklizna perforacija according to catalogue of antiskid perforation
dodatne operacije additional operation	sečenje, savijanje, tig-mig zavarivanje cutting, bending, tig-mig welding
količine quantity	nema min. količine, prototipovi, male, srednje, velike serije, izrada po zahtevu no min. quantity, prototype, small, medium, big quantity, custom production
napomena notice	proizvodnja prema DIN-ISO standardima production according to DIN-ISO standards



PERFORIRANI NAVOZI I DELOVI ZA AUTOTRANSPORT

PERFORATED PARTS FOR CAR CARRIERS AND TRAILERS



materijal material	čelik,aluminium... steel,aluminum...
debljina thickness	max 5mm
dimenzija dimension	max.1500x3000 limovi / profili i gazišta po zahtevu max.1500x3000 metal sheet /profiles and grating according to request
otvori perforacije perforation	prema katalogu protivklizna perforacija according to catalogue of antiskid perforation
dodatne operacije additional operation	sečenje,lasersko sečenje,savijanje,tig-mig zavarivanje cutting,laser cutting,bending,tig-mig welding
količine quantity	nema min.količine,prototipovi,male,srednje,velike serije,izrada po zahtevu no min.quantity,prototype,small,medium,big quantity,custom production
primena application	šlep prikolice,auto prikolice,poljoprivredne mašine car carriers,trailers,agricultural equipment



PRIMERI SAVIJANJA PROFILA - EXAMPLES OF PROFILE BENDING

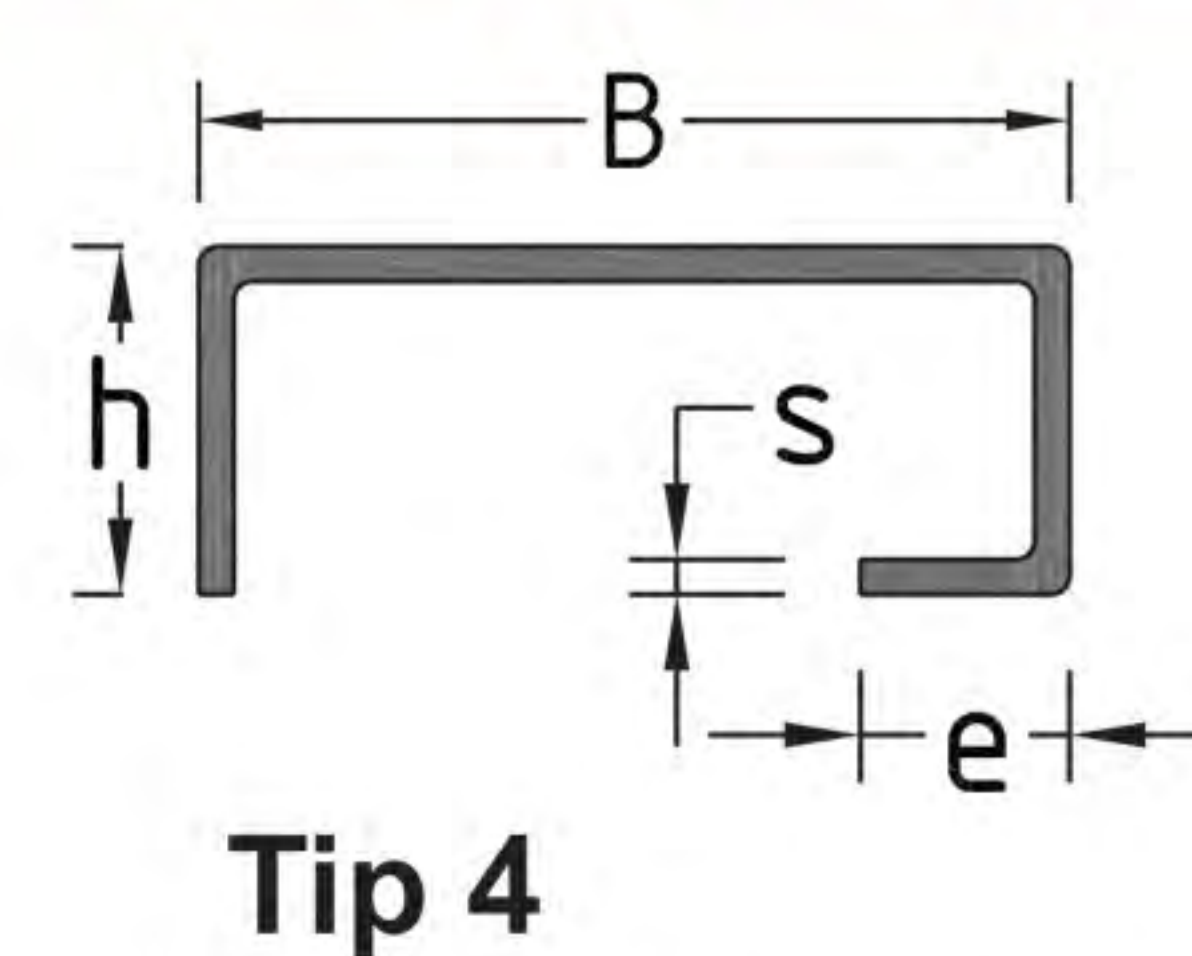
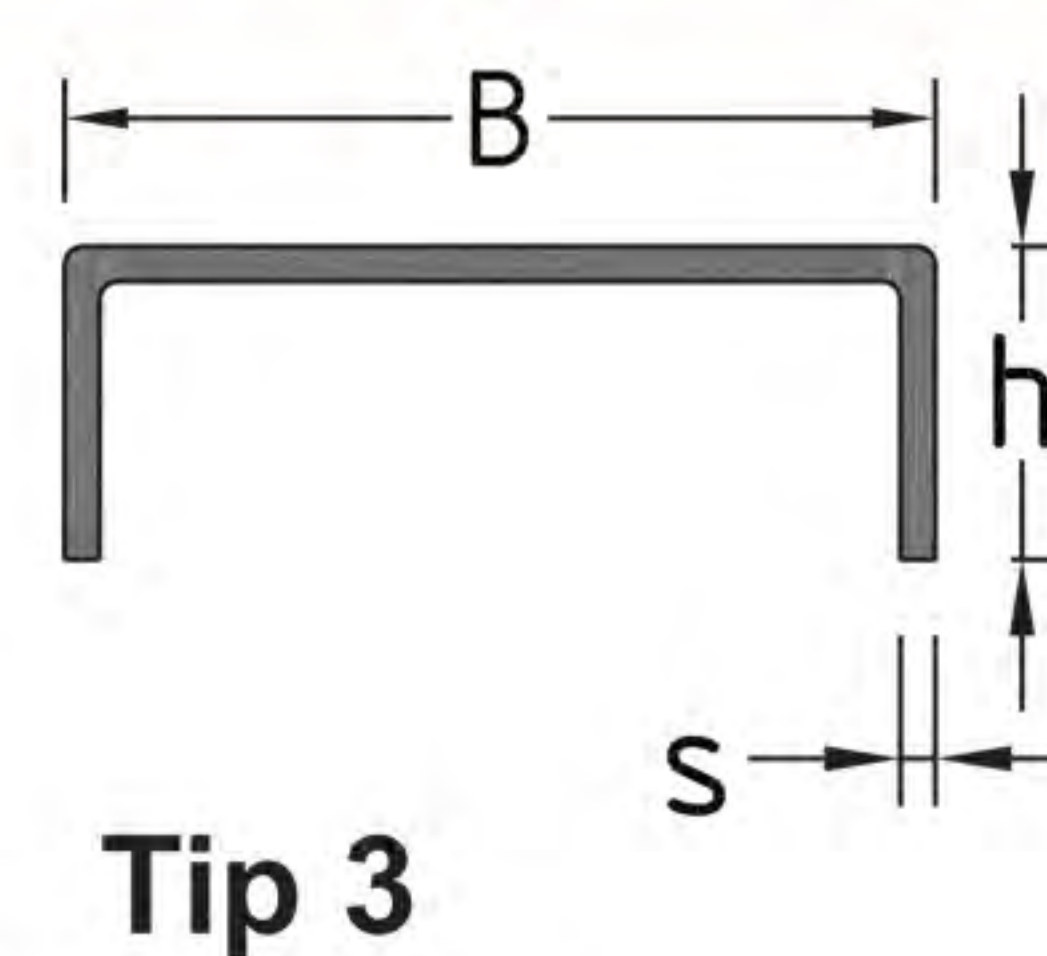
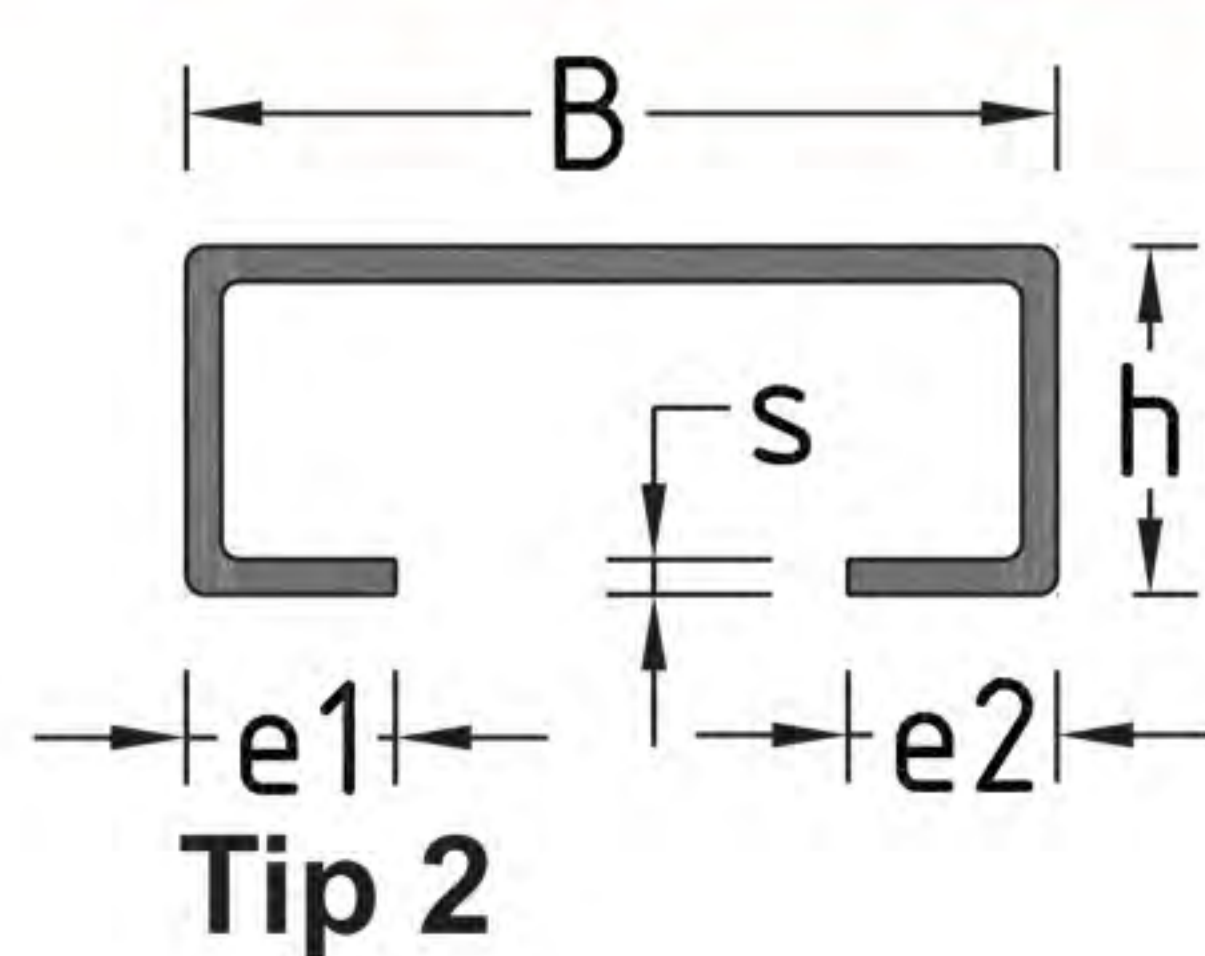
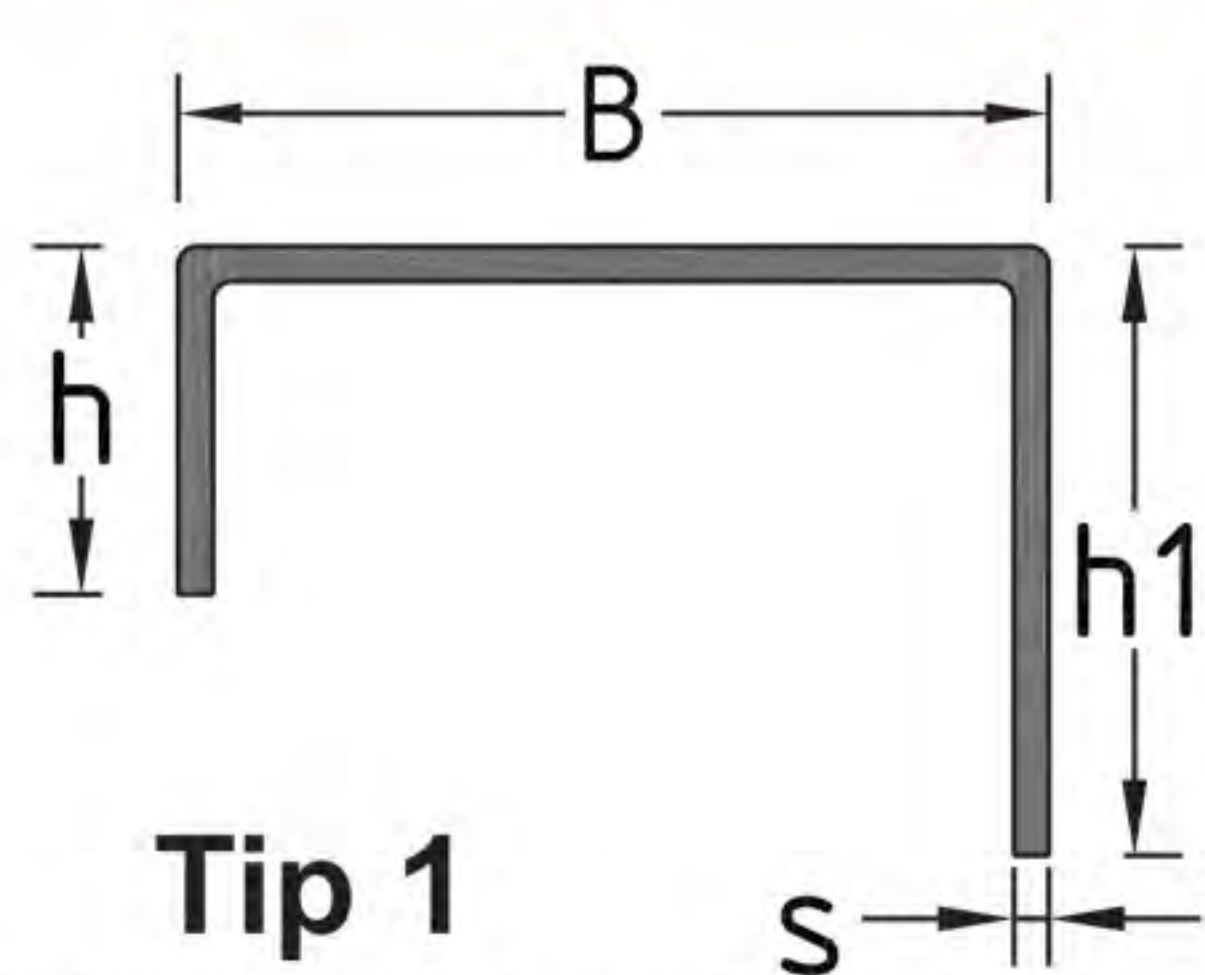

PROTIVKLIZNA GAZIŠTA - PROFILI

ANTISKID GRATINGS - PROFILES

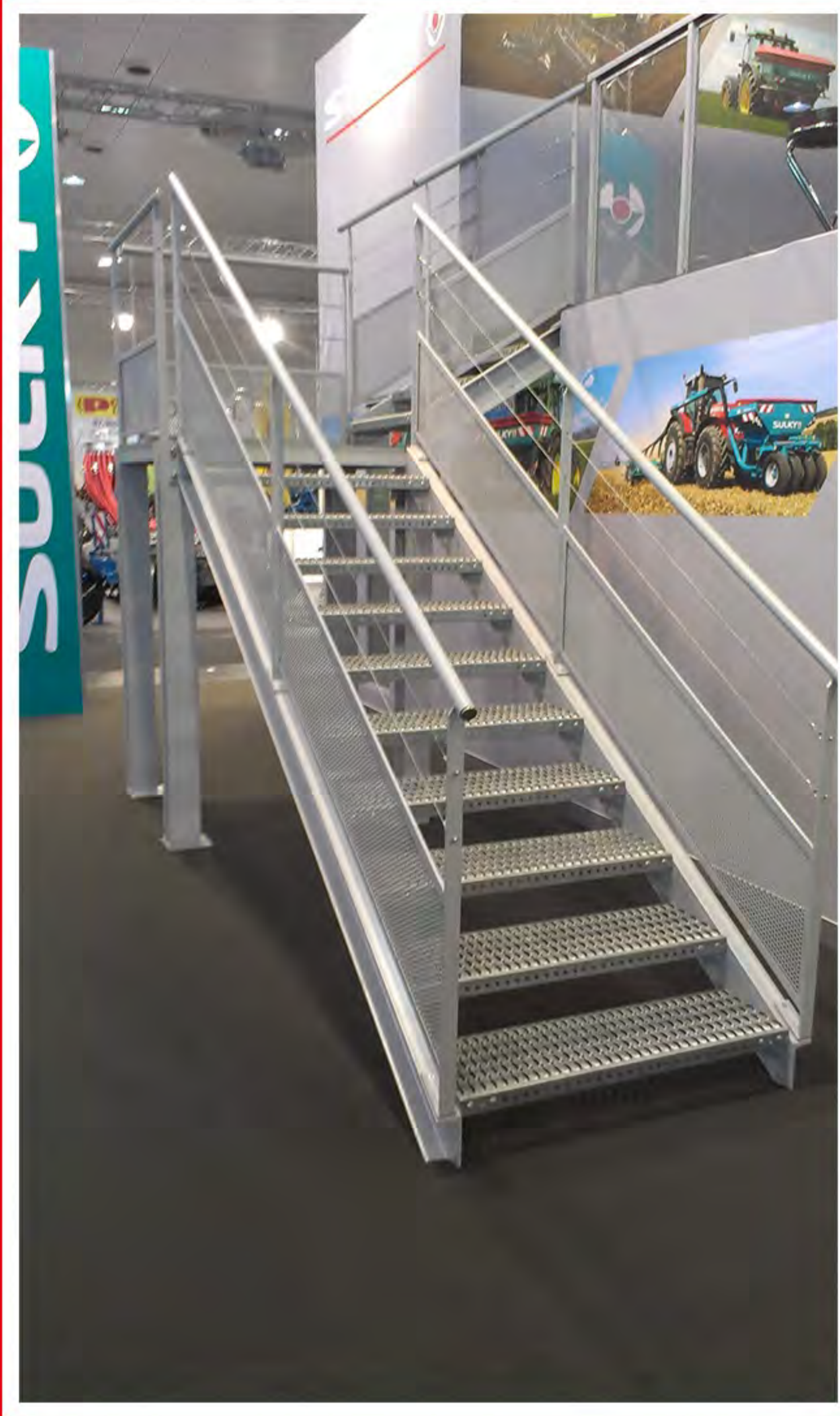

materijal material	čelik, prohrom, pocinkovani, aluminium... steel, stainless steel, galvanized, aluminum...
debljina thickness (S)	standard 2/2,5/3mm veće debljine po zahtevu / thicker on request
širina profila profile width (B)	standard 150/200/240/270/300mm ili po zahtevu / or on request
dužine profila profile length	max. 3000mm
otvori perforacije perforation	prema katalogu protivklizna perforacija according to catalogue of antiskid perforation
dodatne operacije additional operation	sečenje, lasersko sečenje, savijanje, tig-mig zavarivanje cutting, laser cutting, bending, tig-mig welding
količine quantity	nema min. količine, prototipovi, male, srednje, velike serije, izrada po zahtevu no min. quantity, prototype, small, medium, big quantity, custom production
napomena notice	produkcija prema DIN-ISO standardima production according to DIN-ISO standards

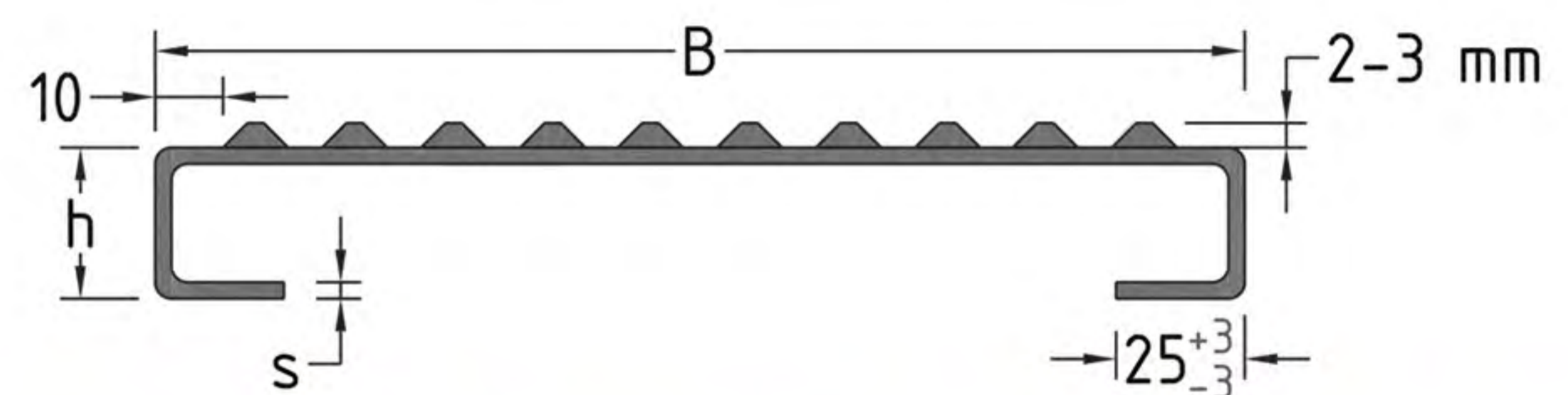
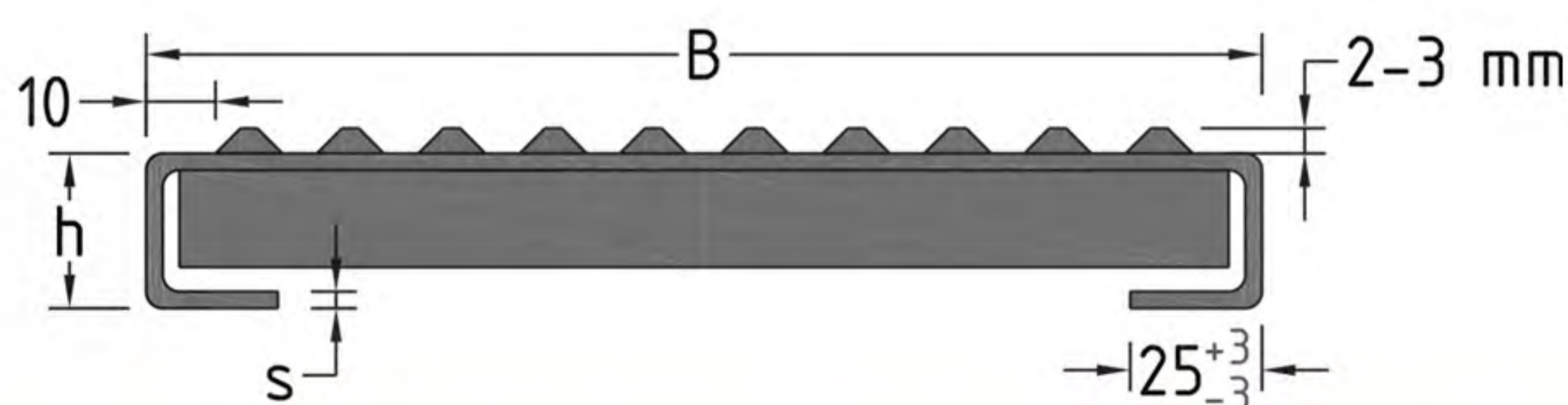

PRIMERI SAVIJANJA PROFILA - EXAMPLES OF PROFILE BENDING

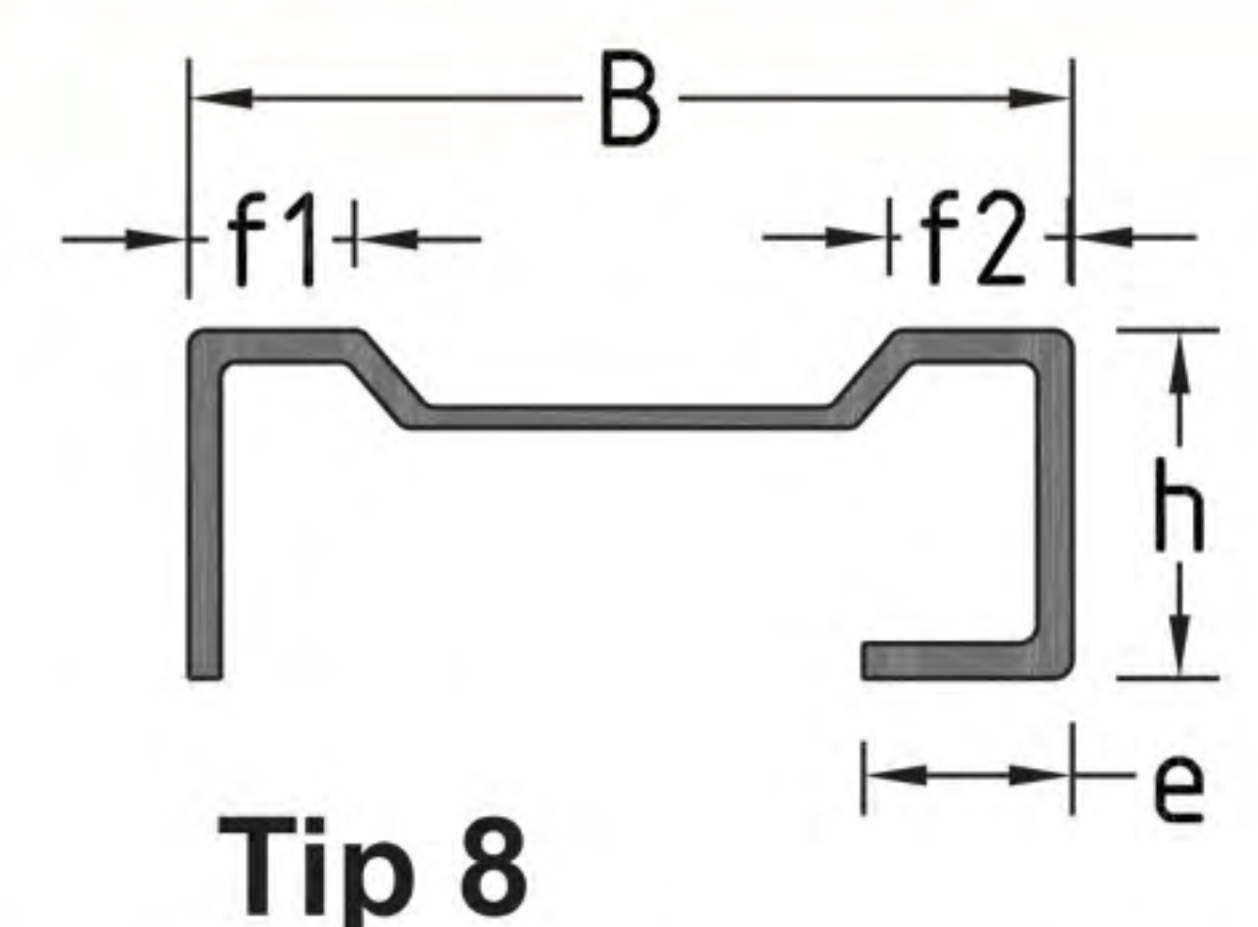
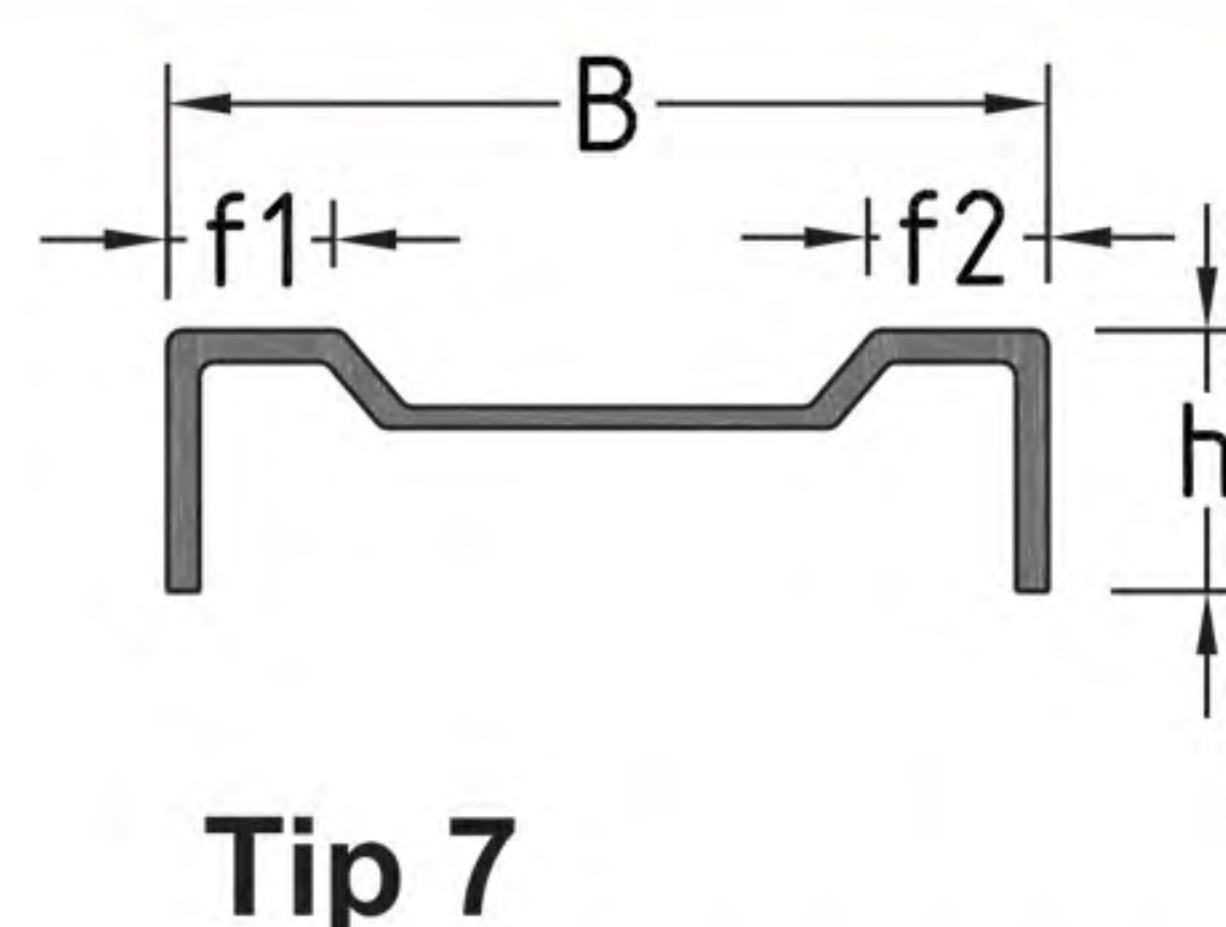
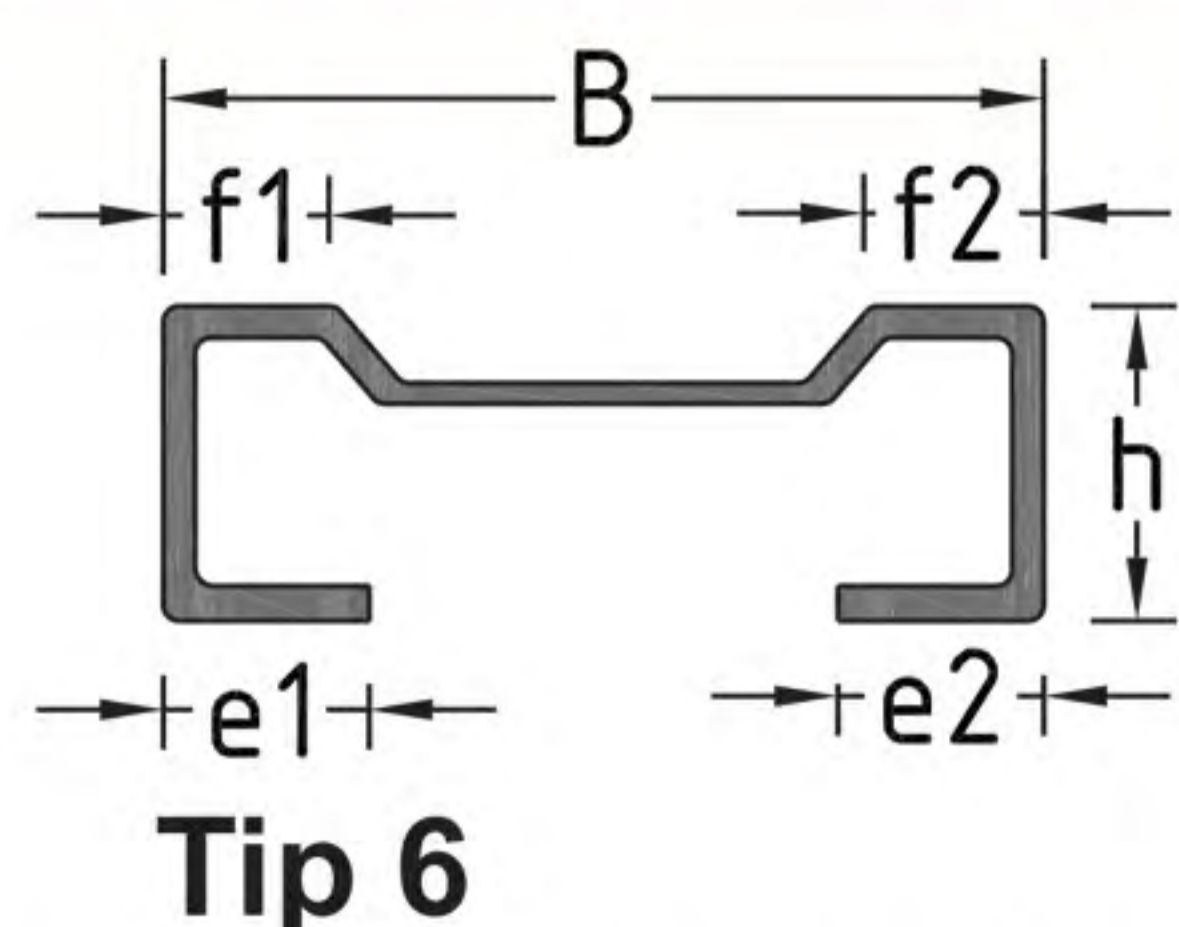
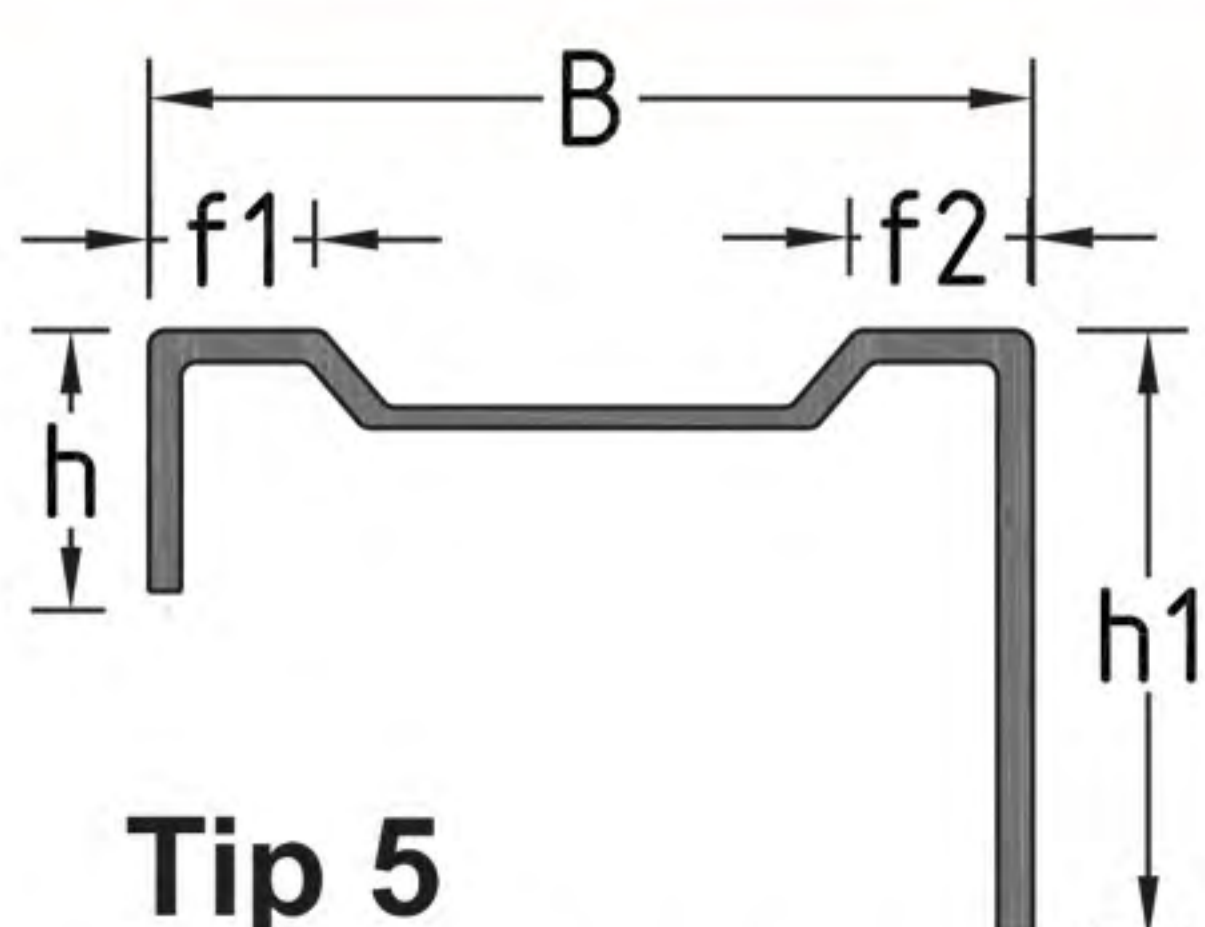

PROTIVKLIZNI STEPENICI

ANTISKID STAIRWAY STEPS

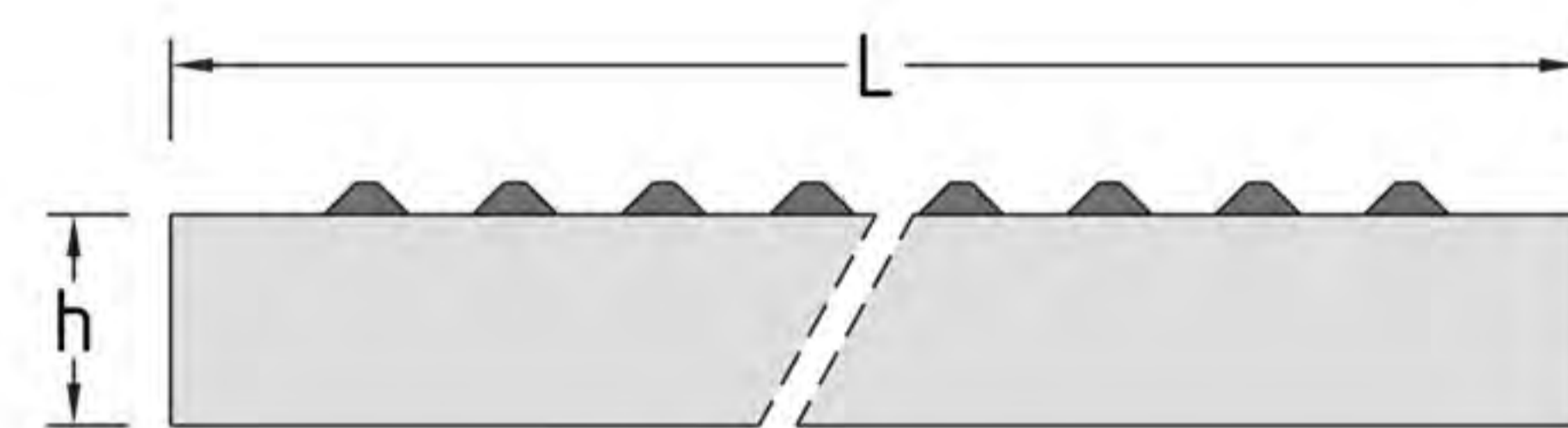
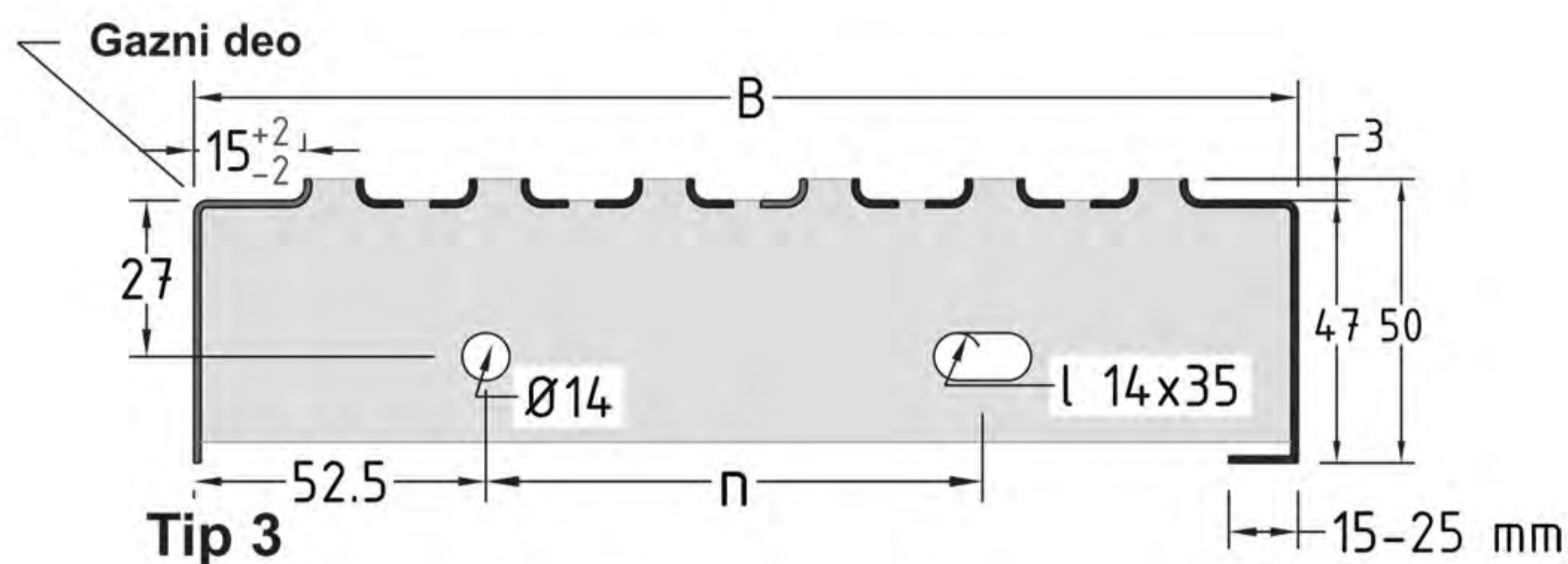
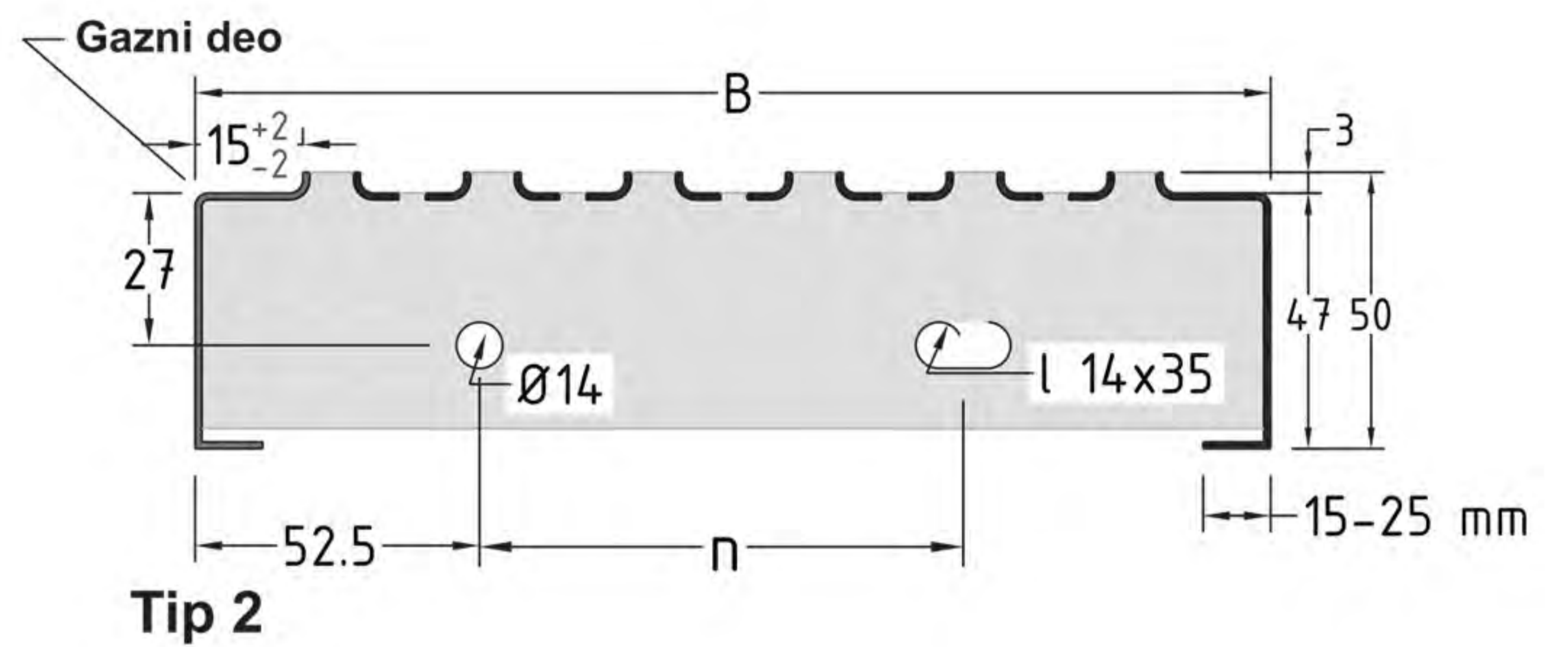
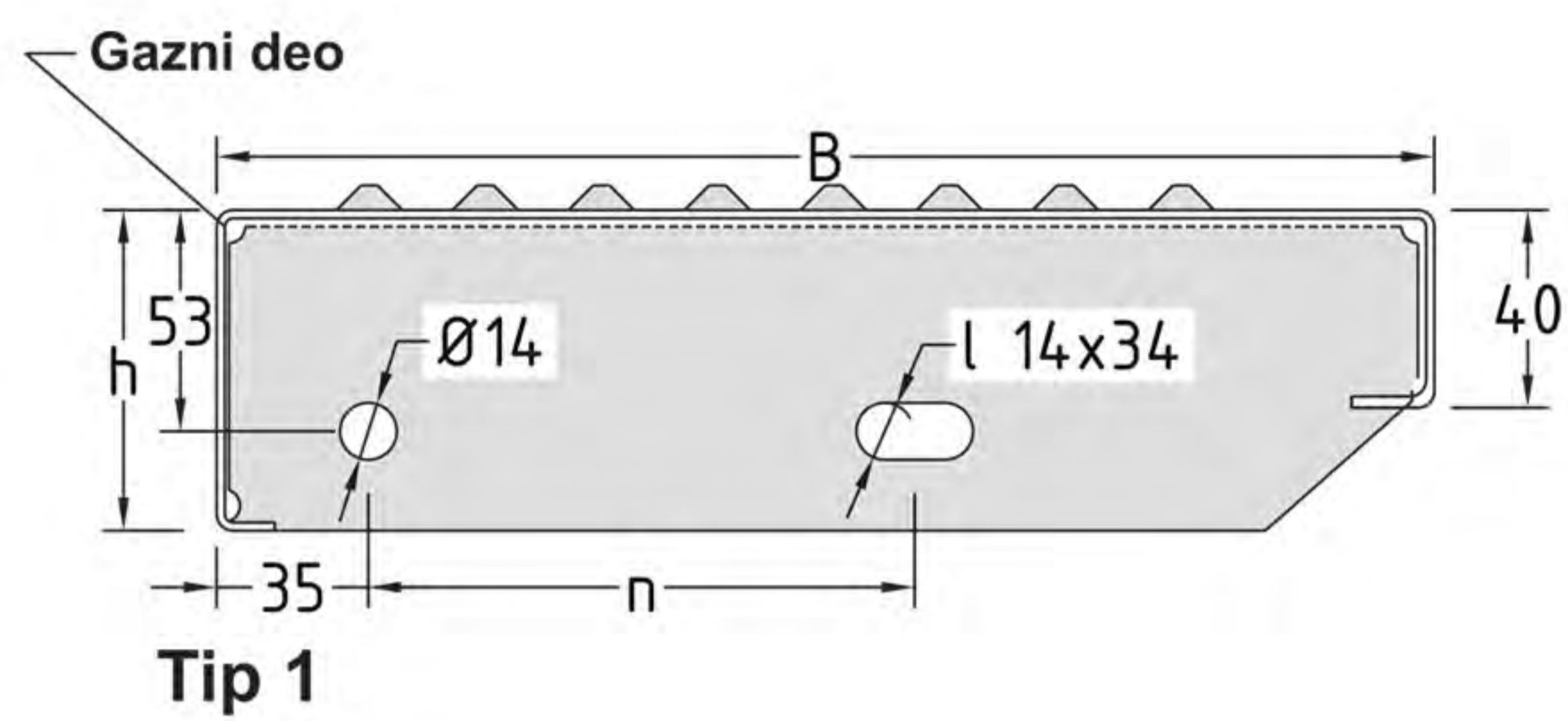

materijal material		čelik, prohrom, pocinkovani, aluminium... steel, stainless steel, galvanized, aluminum...
debljina thickness	(S)	standard 2/2,5/3mm, veće debljine po zahtevu / thicker on request
širina width	(B)	standard 150/200/240/250/270/300/330mm ili po zahtevu / or on request
dužine length	(L)	standard 500/700/800/900/1000/1200mm ili po zahtevu / or on request
visina height	(h)	standard 40/50/60/70mm
otvori perforacije perforation		prema katalogu protivklizna perforacija according to catalogue of antiskid perforation
površinska zaštita surface treatment		bez zaštite ili toplocinkovano raw finish or hot deep galvanized
količine quantity		nema min. količine, prototipovi, male, srednje, velike serije, izrada po zahtevu no min. quantity, prototype, small, medium, big quantity, custom production



PROTIVKLIZNI SPIRALNI STEPENICI

ANTISKID SPIRAL STAIRCASES

širina width	zavisno od dužine R i ugla stepenika 20° ili 24° depend of length R and angle of stair case 20° or 24°
visina *h height *h	standard 50/60/70/74mm
napomena notice	sve ostalo kao kod protivkliznih stepenica all other details same like antiskid stairway steps

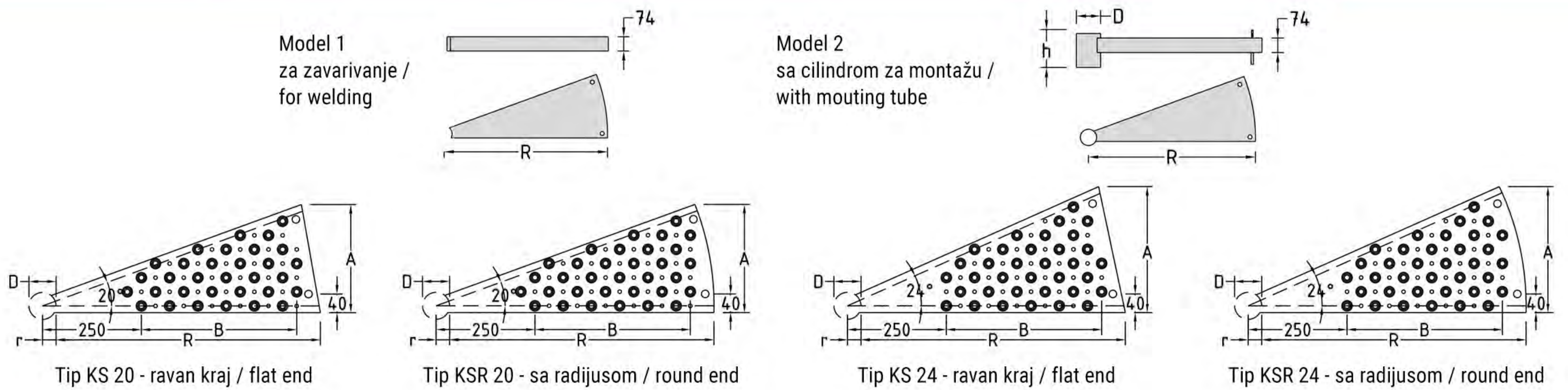

PROTIVKLIZNI STEPENICI ZA MERDEVINE

SAFETY RUNGS FOR LADDERS

materijal material	čelik, prohrom, pocinkovani, aluminium... steel, stainless steel, galvanized, aluminum...
debljina thickness	standard 2/2,5/3mm ,veće debljine po zahtevu / thicker on request
širina width	standard 25/30/35/55/60mm ili po zahtevu / or on request
dužine length	max.3000mm ili po zahtevu / or on request
visina *h height *h	standard 15/20/25/30 ili po zahtevu / or on request
otvori perforacije perforation	prema katalogu protivklizna perforacija - merdevine according to catalogue of antiskid perforation for ladders
površinska zaštita surface treatment	bez zaštite ili toplocinkovano raw finish or hot deep galvanized
količine quantity	nema min.količine, prototipovi, male, srednje, velike serije, izrada po zahtevu no min. quantity, prototype, small, medium, big quantity, custom production

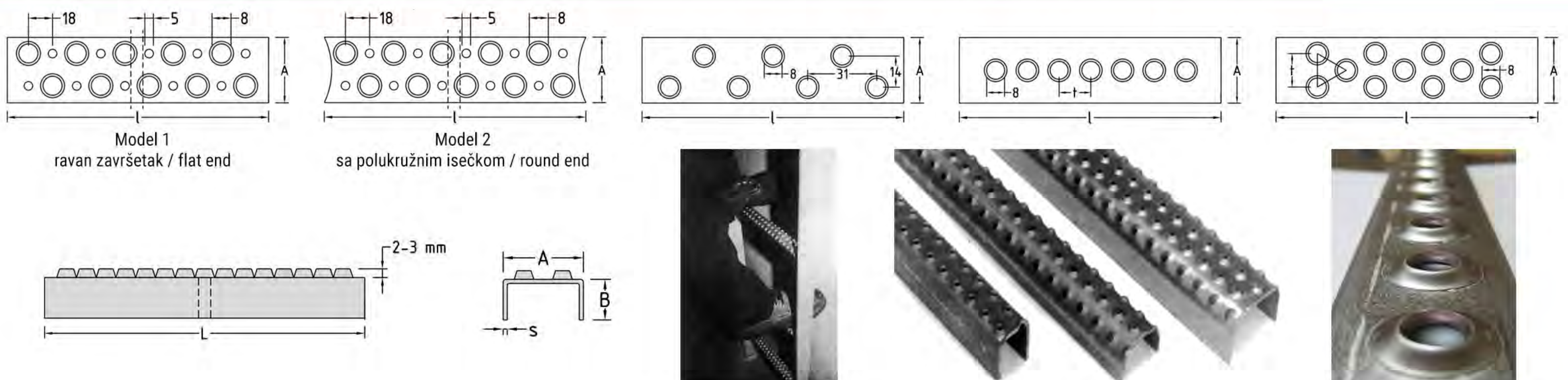

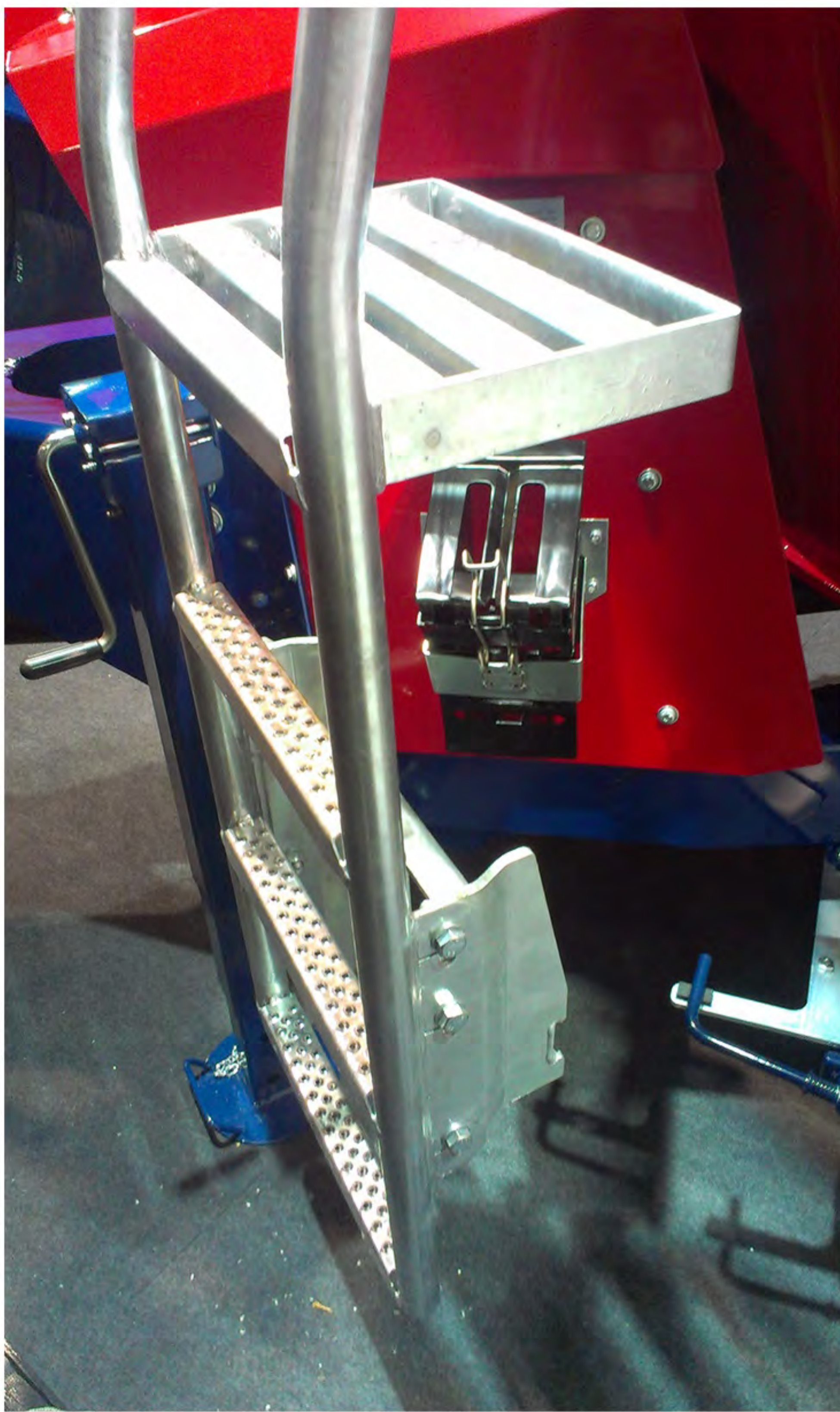
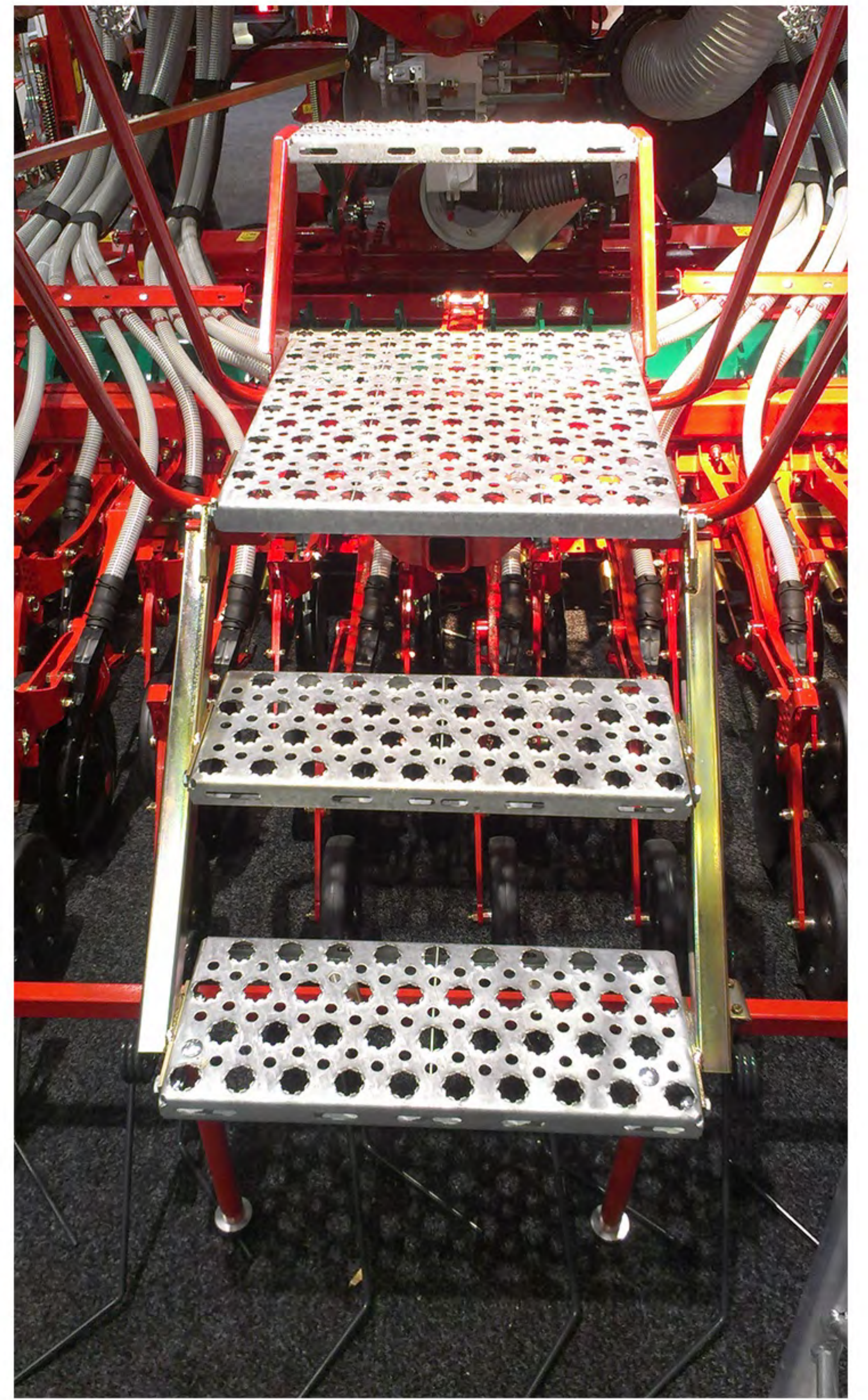

REŠETKASTA VARENA GAZIŠTA

STEEL WELDED GRATINGS

■ Gazišta se proizvode od sledećih materijala:

- Čelik toplovaljani u kvalitetu č0361 (ST 37-2 / S235 JRG)
- Aluminijski lim Al 99,5 i AlMg 3
- Prohrom č4580-č4574 (AISI 304-316)

Gazišta se isporučuju:

- Bez površinske zaštite.
- Sa površinskom zaštitom - (TZn) Toplocinkovana u skladu sa DIN 50 976.
- Farbana po zahtevu kupca.

■ Gratings are made of the following materials:

- Hot-rolled steel in the quality (ST 37-2 / S235 JRG)
- Aluminium
- Stainless steel (AISI 304-316)

Treads are available with:

- Without surface protection.
- With surface protection - hot dipped galvanizing according to DIN 50 976th.
- Painted upon request.

REŠETKASTA GAZIŠTA SA POLUFLAHOM - MODEL RGP

WELDED GRATINGS - MODEL RGP

Najstandardnija dimenzija ovog modela je : 2/4-33x33/30 mm

Most standard dimensions of this model is: 2/4-33x33/30 mm

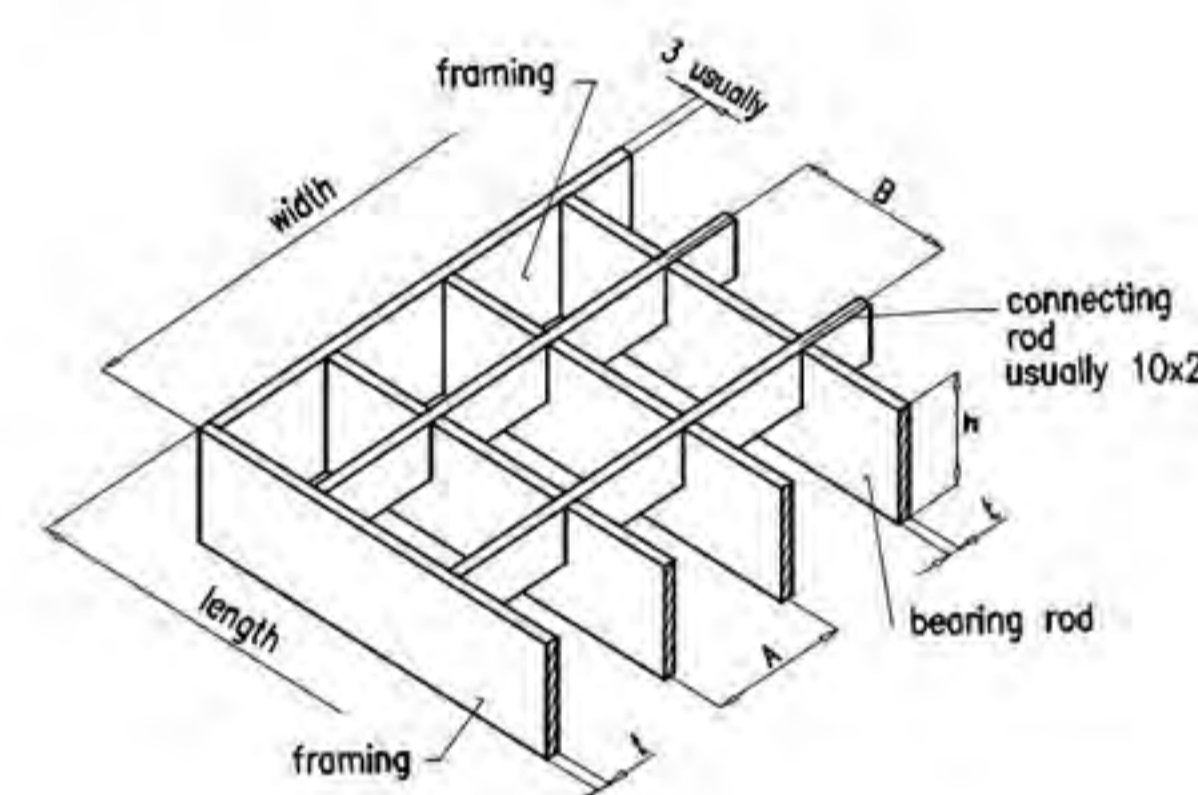

REŠETKASTA GAZIŠTA SA PUNIM FLAHOM - MODEL RG

WELDED GRATINGS - MODEL RG

Najstandardnija dimenzija ovog modela je: 3/5-30x30/30 mm

Most standard dimensions of this model is: 3/5-30x30/30 mm

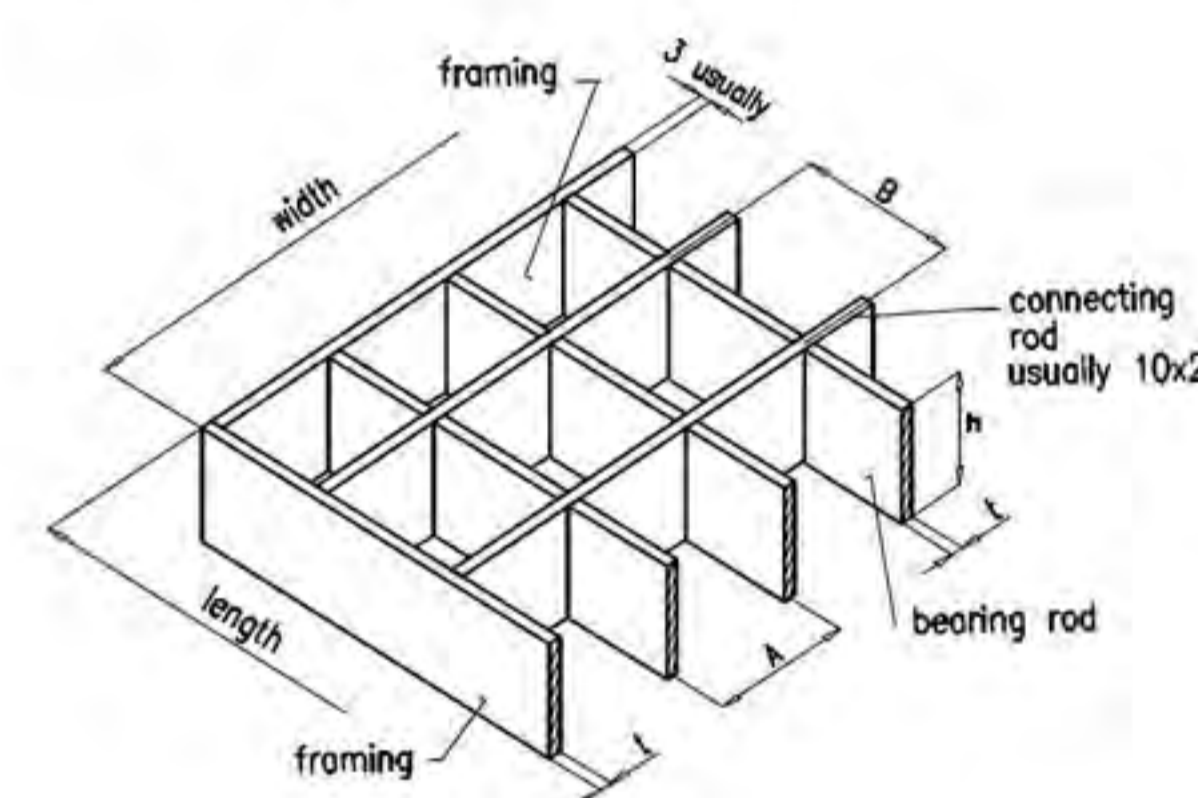

REŠETKASTA GAZIŠTA - STEPENICE

WELDED GRATINGS - STAIR STEPS

■ Modeli stepenika:

- Rešetkasti stepenici sa poluflahom * model RSP
- Rešetkasti stepenici sa punim flahom * model RS
- Spiralni rešetkasti stepenici * model SRS1
- Spiralni rešetkasti stepenici * model SRS2

Dimenzije:

- Standardne ili po zahtevu kupca

Fiksiranje stepenika za postojeću konstrukciju:

- Šrafova M12 - 4 šrafa po jednom stepeniku
- Varenjem za postojeću konstrukciju

■ Models of stair steps:

- Stair step * model RSP
- Stair step * model RS
- Spiral stairs * model SRS1
- Spiral stairs * model SRS2

Dimensions:

- Standard or by customer's request

Fixing for existing construction:

- Screws M12 – attached with 4 screws for each stair step
- Welding for existing construction



Stepenik – modeli RSP (sa poluflahom)
sa protivkliznim nagaznim profilom
Stair step - model RSP

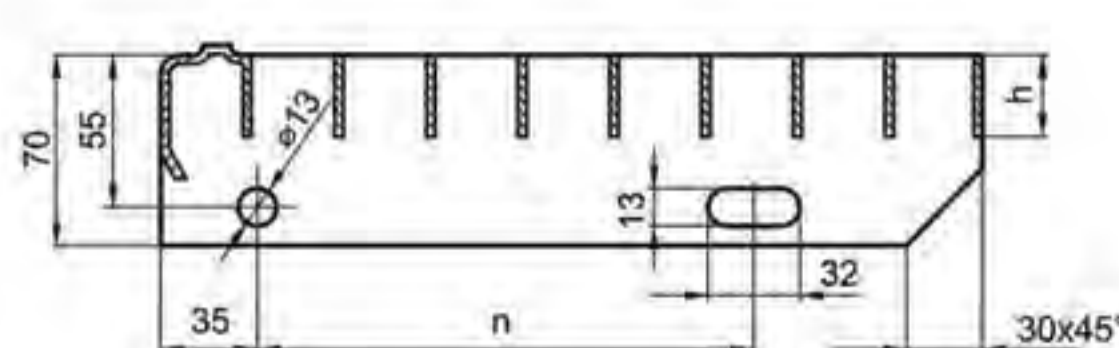

Stepenik – model RS (sa punim flahom):
bez protivkliznog nagaznog profila:
Stair step - model RS

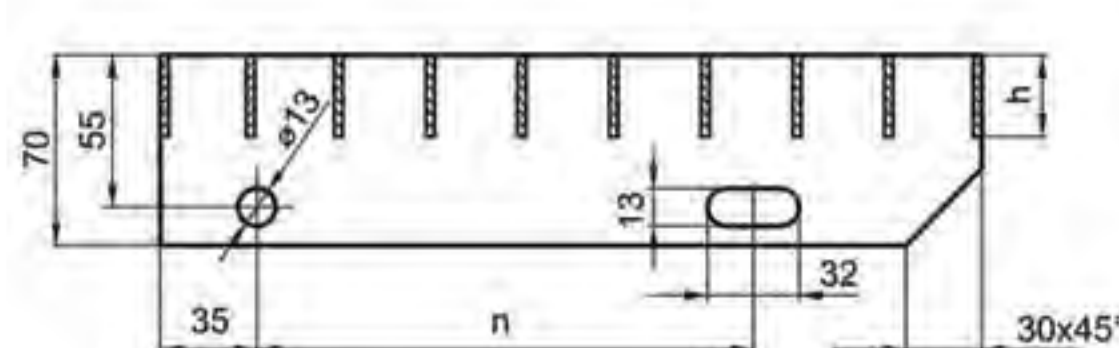

Spiralni rešetkasti stepenik
Spiral stair step

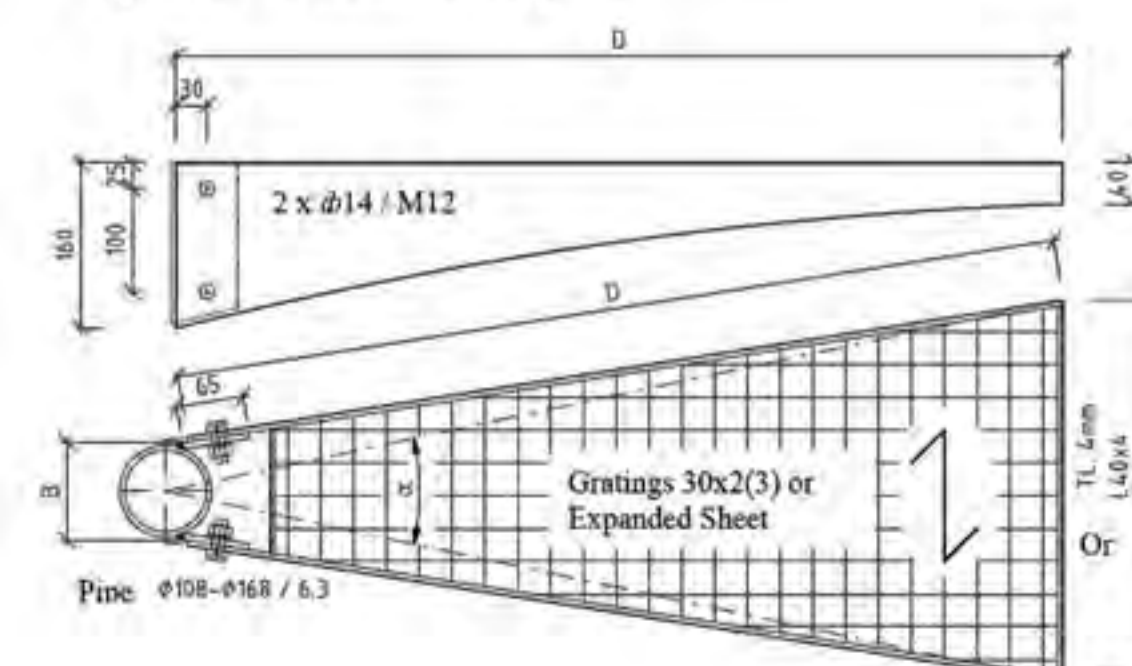



PLEHOVI, TEPISIJE I KOLICA ZA PEKARE

BAKING TRAYS, TOOLS AND TROLLEY

- Perfom je vodeći proizvođač plehova i tepsija u Srbiji i regionu. Decenijama radimo na razvoju ovih proizvoda zajedno sa našim kupcima prateći njihove potrebe. Kvalitet, odgovornost i fleksibilnost u radu kao i upotreba najboljih materijala za proizvodnju, predstavljaju garanciju visokog kvaliteta naših proizvoda. Pored standardnih proizvoda mi proizvodimo plehove i tepsije po vašem zahtevu.

Svi naši proizvodi imaju potrebne ateste i provere zdravstvene ispravnosti i mogu se koristiti u skladu sa HACCP sistemom kvaliteta.

Materijal: Aluminijumski tvrdi lim AlMg3, prohromski lim Č4580.

- Perfom is a leading manufacturer of baking trays in Serbia and Balkans region. For many years we have developed these products together with our customers, according to their demand and needs. Quality, responsibility and flexibility in production, as well as use of the best quality raw materials are the guarantee of our high quality products. We produce standard and custom made trays according to your demands.

All our products have the necessary certificates and safety verifications, and can be used in accordance with the HACCP quality system.

Material: Aluminum sheet AlMg3, stainless steel AISI 304.

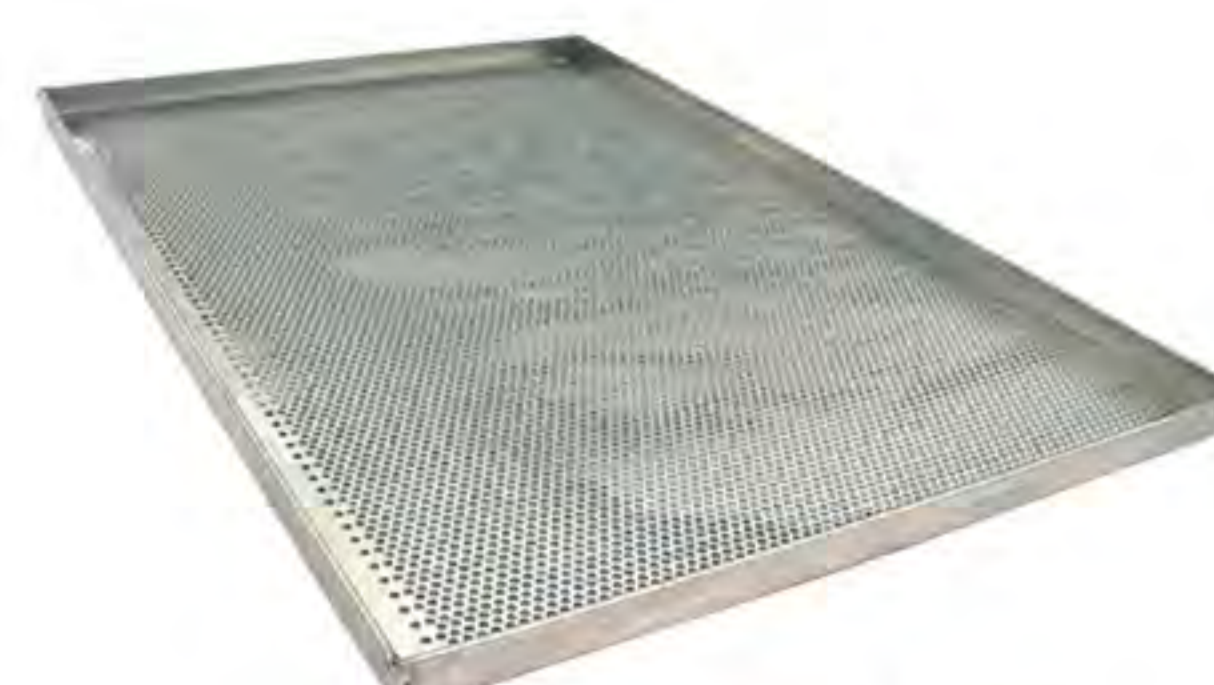

Ravni perforirani pleh



Ravni plehovi



Valovani plehovi



Baget pleh



Pleh za kasetni hleb



Pržulja



Pleh za tost hleb



Tepsija za burek



Tepsija za hleb



Tepsija za pizzu



Pleh za hamburger lepinju

Kolevka za fermentacionu komoru



Kolica



Pekarski pribor

KORPE ZA OTPATKE

WASTEPAPER BASKETS

- **Materijal:** čelični hladnovaljani - prohrom
- **Površina:** pocinkovano, bojeno po Ral karti
- **Perforacija:** po izboru iz kataloga Perfom - a

- **Material:** Mild steel-stainless steel
- **Surface:** Galvanised-Painting Ral colours
- **Perforation:** On request from Perfom

Modeli / Models

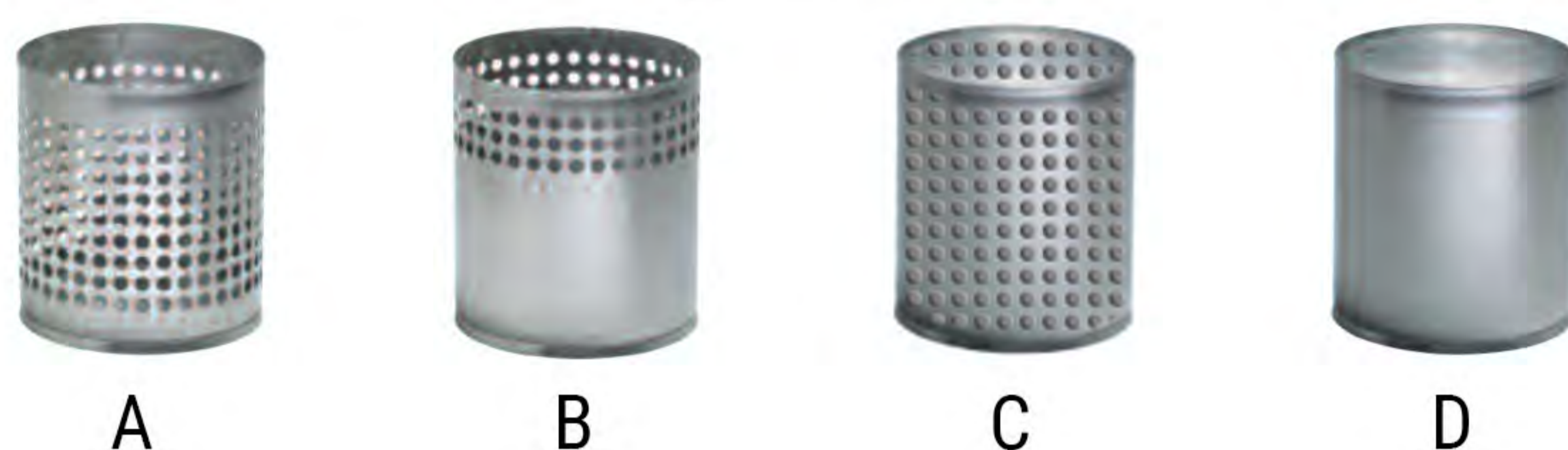

Prilikom porudžbine navedite oznaku serije i model po želji (A,B,C ili D).
When placing order, please choose type and model (A,B,C or D).

Seriya / Type	Model / Model	Prečnik (D) mm / Diameter (D) mm	Visina (H) mm / Height (H) mm	Litara / Litres
14	A-B-C-D	255	280	14
18	A-B-C-D	255	370	18
21	A-B-C-D	290	320	21
31	A-B-C-D	290	470	31
83	A-B-C-D	420	590	83

DIZAJNIRATE KORPU PO VAŠOJ ŽELJI, IZABERITE BOJU, PERFORACIJU...
CREATE YOUR OWN BASKET AS YOU IMAGINE, CHOOSE COLOR, PERFORATION...

Primeri - serija 18, model A
Examples - type 18, model A



Sa priborom za kačenje
With hanging accessories



NOSAČI KABLOVA

CABLE TRAYS

Već 20 godina naši nosači kablova predstavljaju sinonim sigurnog izbora.

For 20 years our trays are synonymous with safe choices.

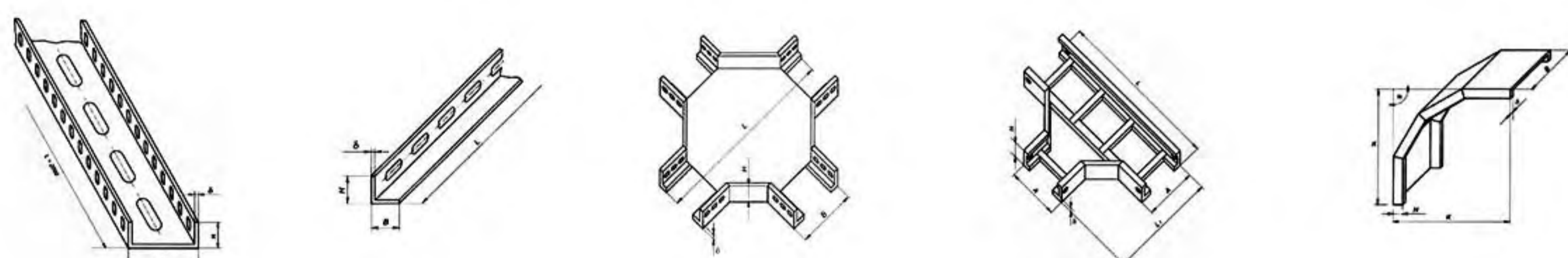

■ **Modeli:** perforirani, neperforirani, rešetkasti

Materijal: pocinkovani, prohromski lim

Površinska zaštita: toplocinkovanje, plastifikacija po ral karti

Dodatni pribor: komplet za montažu, spojnice, konzole, krivine, poklopci, šrafovi, perforirana traka

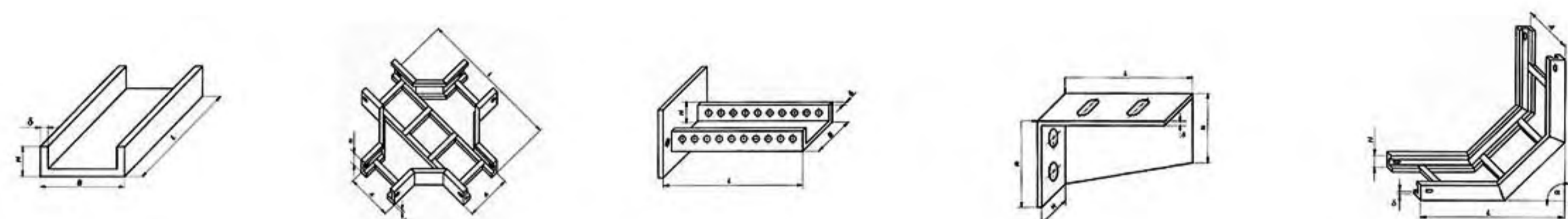

■ **Models:** perforated, solid, ladders.

Material: zinc, stainless steel.

Surface protection: galvanised, powder coated, according to ral card.

Accessories: mounting kit, connectors, brackets, bends, caps, bolts, perforated strip.

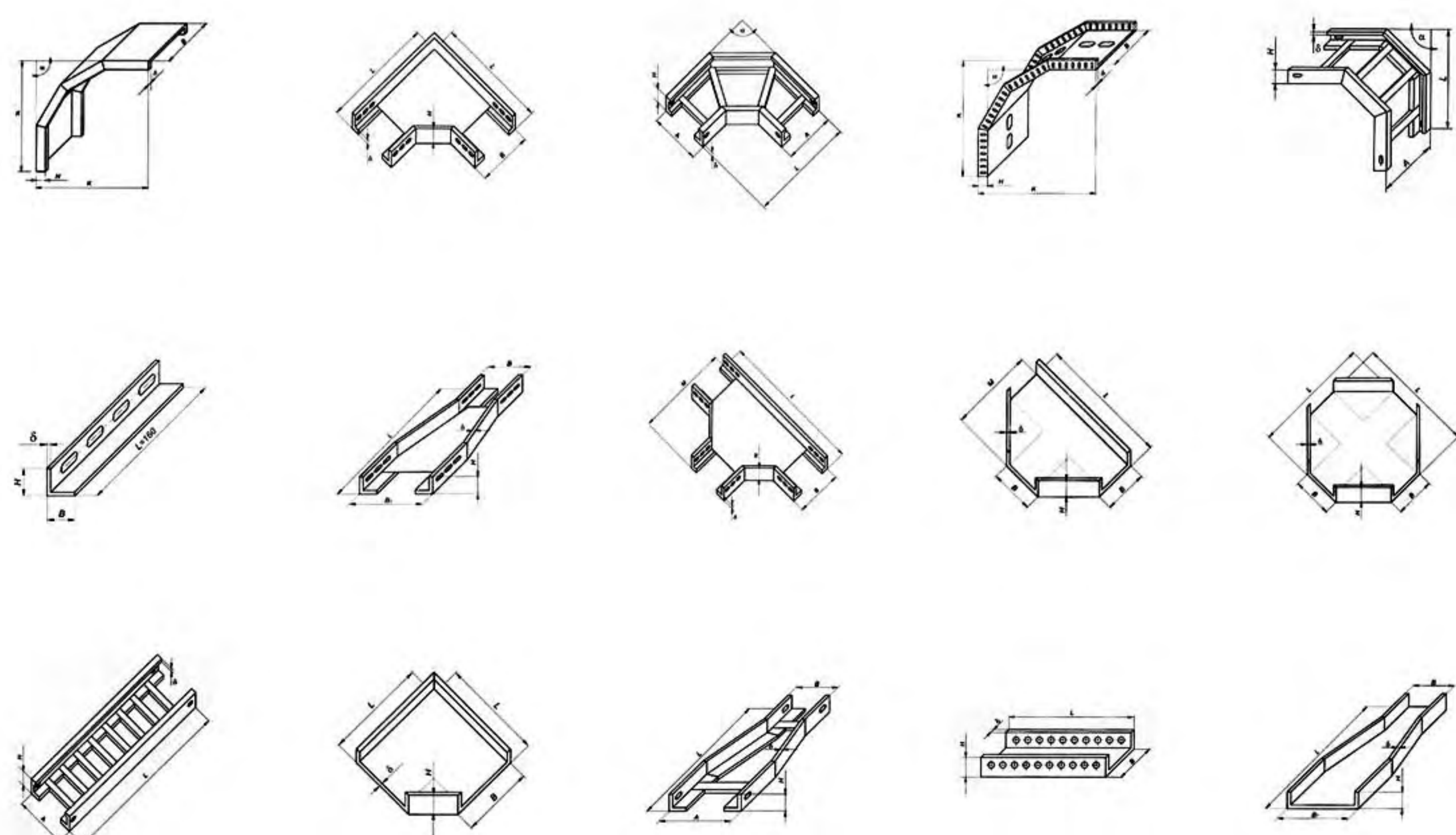

LIMENE STALAŽE I PANOI

METAL RACKS AND PANELS

METALNE STALAŽE

METAL RACKS

Standardne dimenzije police - stalaže:

Širina - A: 950 mm

Dubina - B: 300/400/500/600 mm

Visina - H: 2000 mm

Materijal: Pocinkovani lim, plastificirano po RAL karti

Standard dimensions for racks:

Width - A: 950 mm

Depth - B: 300/400/500/600 mm

Height - H: 2000 mm

Material: galvanized, powder coated - RAL karte

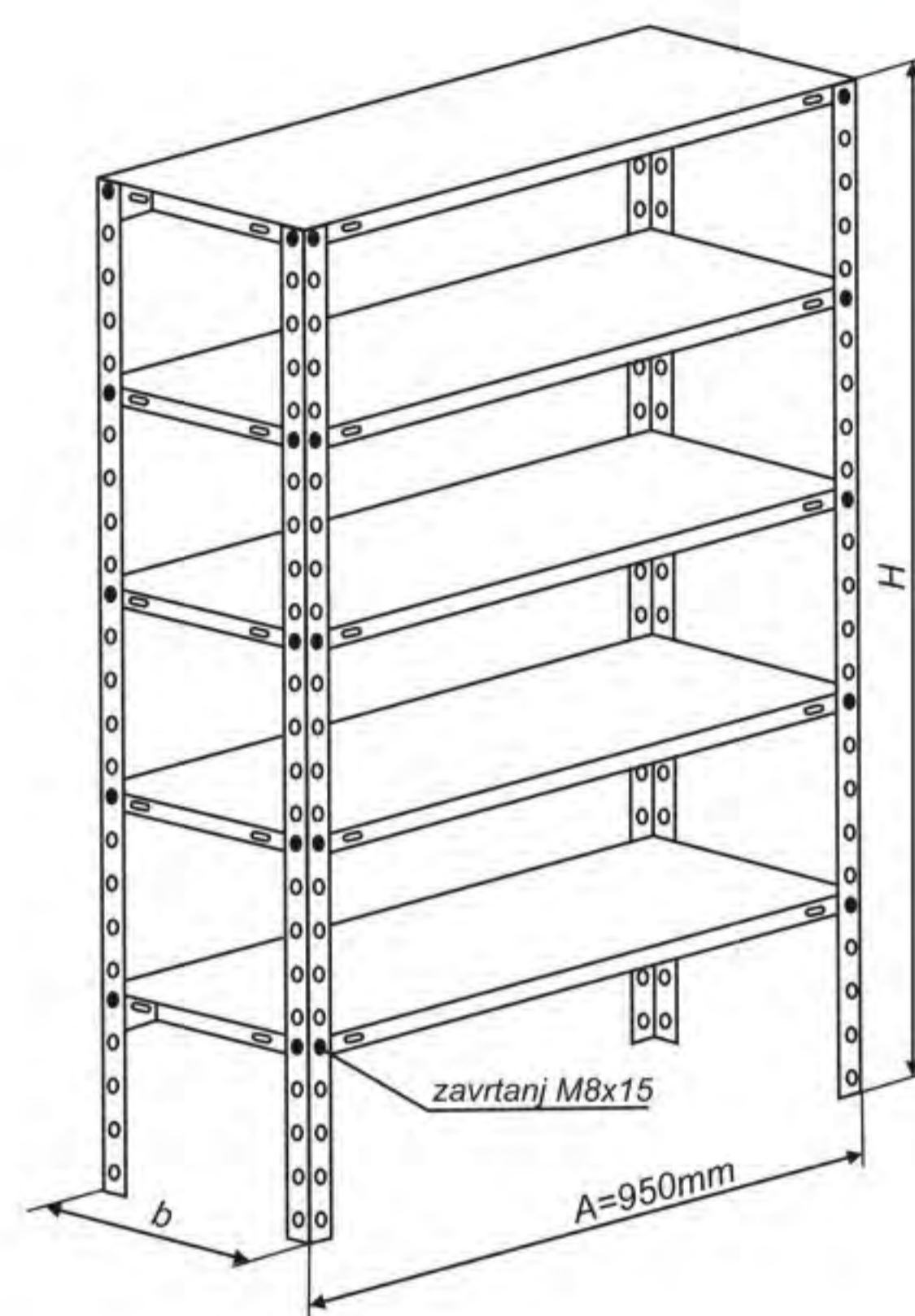

PERFORIRANI PANOI

PERFORATED PANELS

Materijal: čelik hladnovaljani, prohrom, aluminijum

Površinska zaštita: bez zaštite ili plastifikacija po RAL karti

Dimenzije a, b, c: proizvodimo u standardnim dimenzijama i po meri

Debljina lima: standardno 1/1,5 mm, druge debljine po zahtevu

Otvori perforacije: prema katalogu Perfom-a ili po zahtevu

Material: steel cold rolled, stainless steel, aluminium

Surface protection: raw or powder coated - RAL colours

Dimension a, b, c: we produce in standard dimensions and tailor made

Thickness: standard 1/1,5mm, other thickness on request

Perforation: according to Perfom catalogue or on request

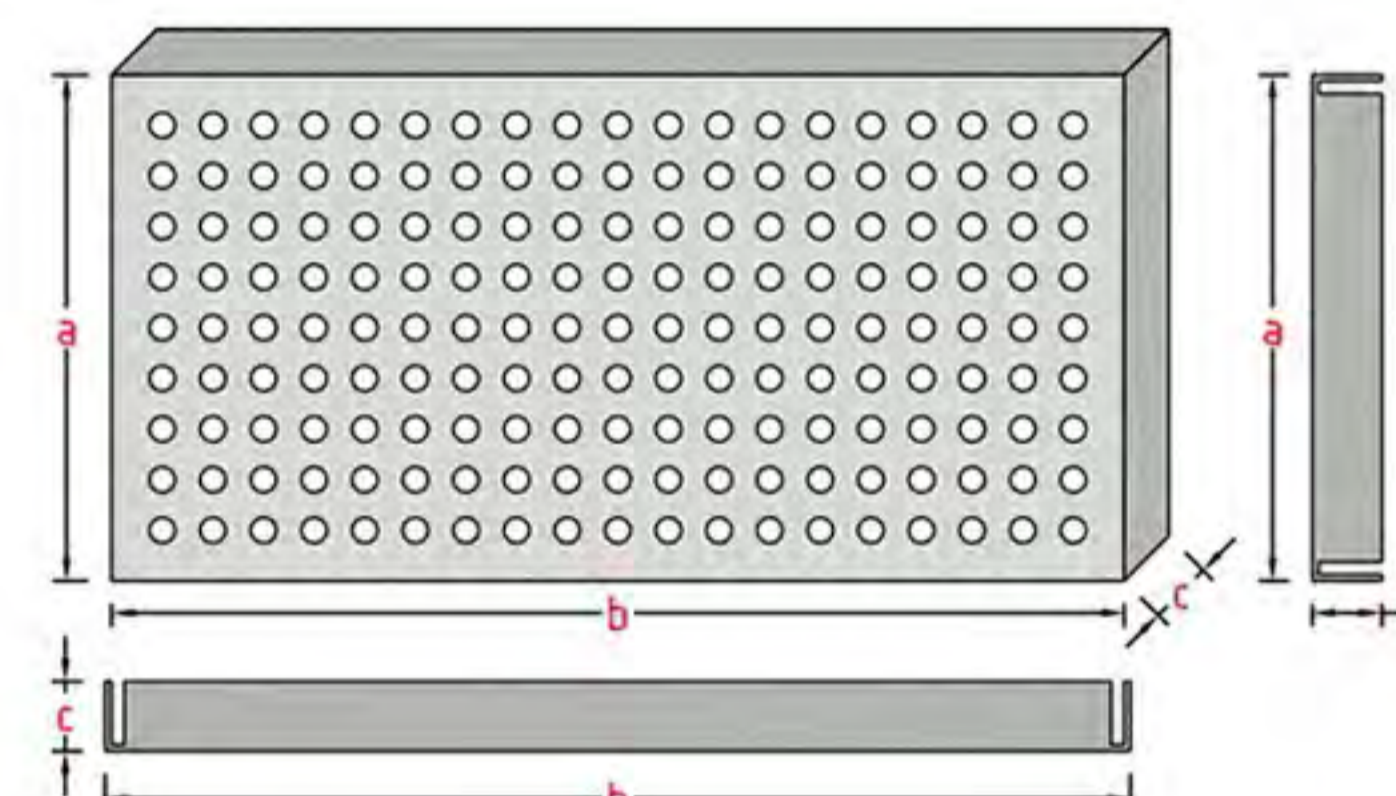

ŽIČANE KUKICE ZA KAČENJE

HOOKS AND HOLDERS



Ral karta za izbor boja za plastifikaciju
Ral color selection

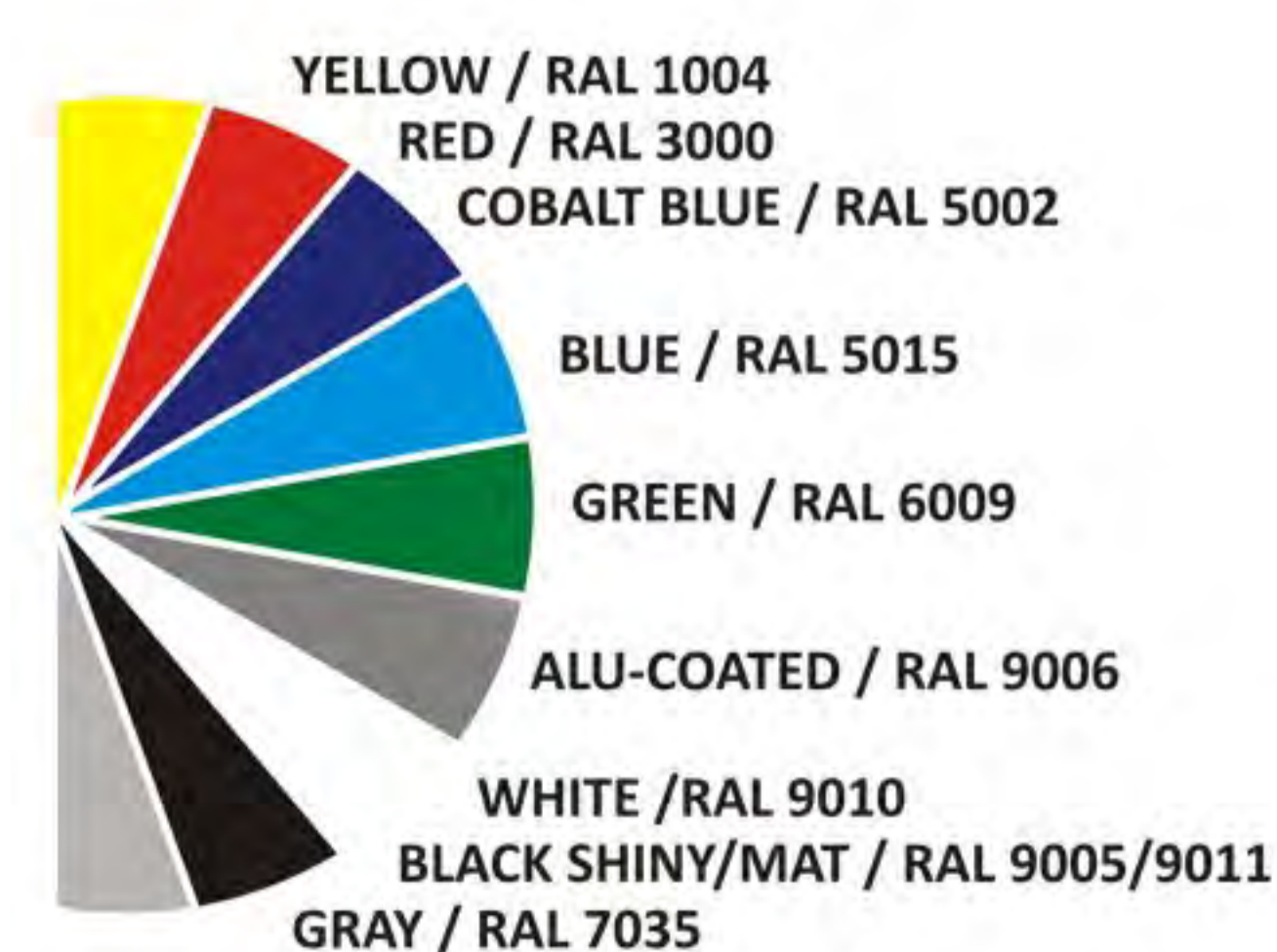

* ili u boji po vašem zahtevu.

* or by your request.



PROIZVODI PO ZAHTEVU CUSTOM PRODUCTS

- Mi želimo da budemo partner u stvaranju vrednosti kroz pružanje usluga i proizvoda koji se zasnivaju na perforaciji i srodnim tehnologijama.

Naše odeljene razvoja i alatnica za izradu alata omogućavaju nam efikasan, ekonomičan i brz odgovor na zahteve tržišta iz domena perforacije i oblikovanja limova.

U skladu sa vašim potrebama i našim mogućnostima, proizvodimo proizvode po zahtevu. Rado ćemo razmotriti i odgovoriti na svaki vaš zahtev.

- We aim at being the ideal partner in creating value through the provision of services and products based on perforation and related technologies.

Our development and toolmaking department allow us efficient, economical and quick response to market demand in the areas of perforation and metal forming.

In accordance with our clients' needs, we manufacture products on demand. We are always ready to evaluate and respond to any client's request.

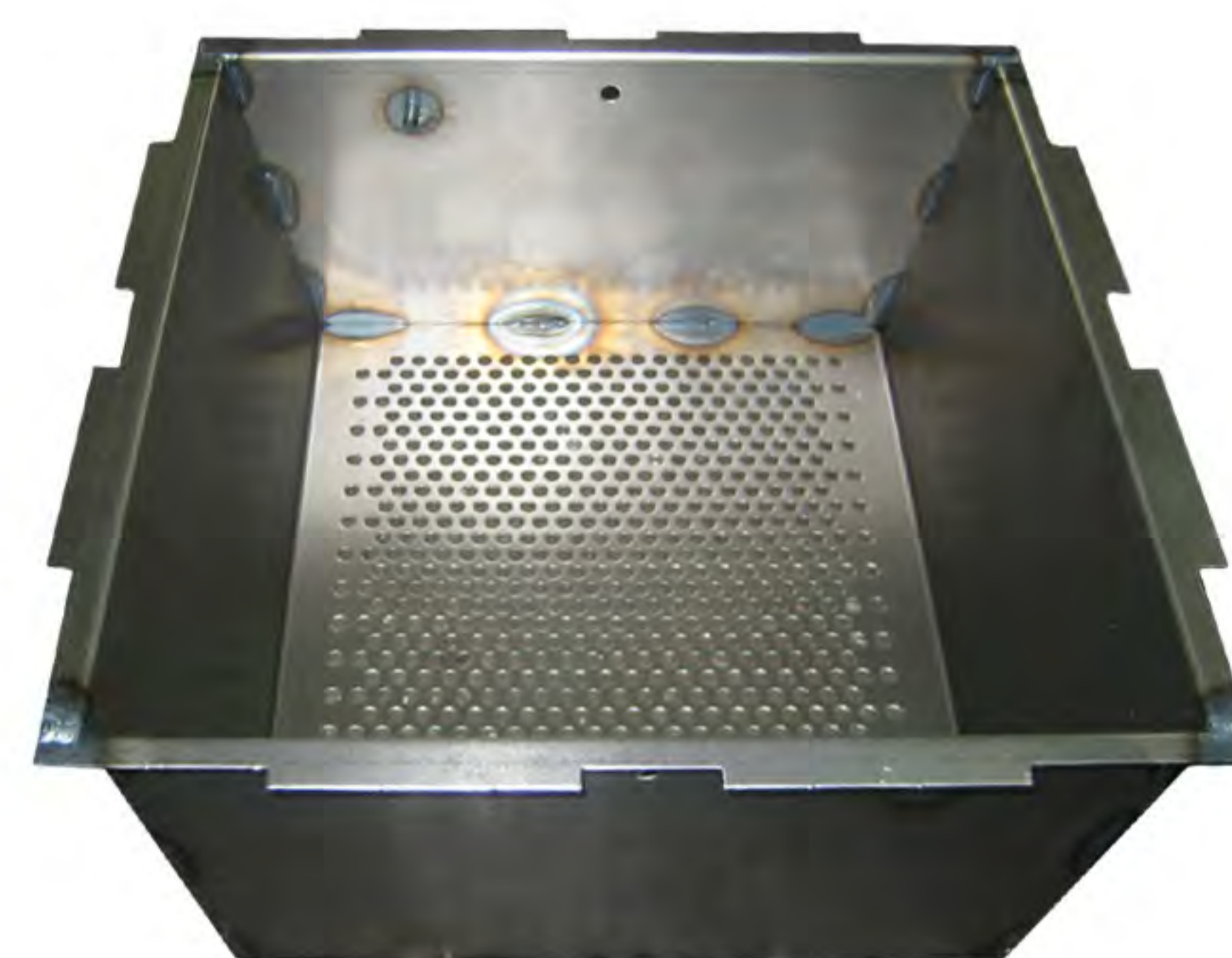
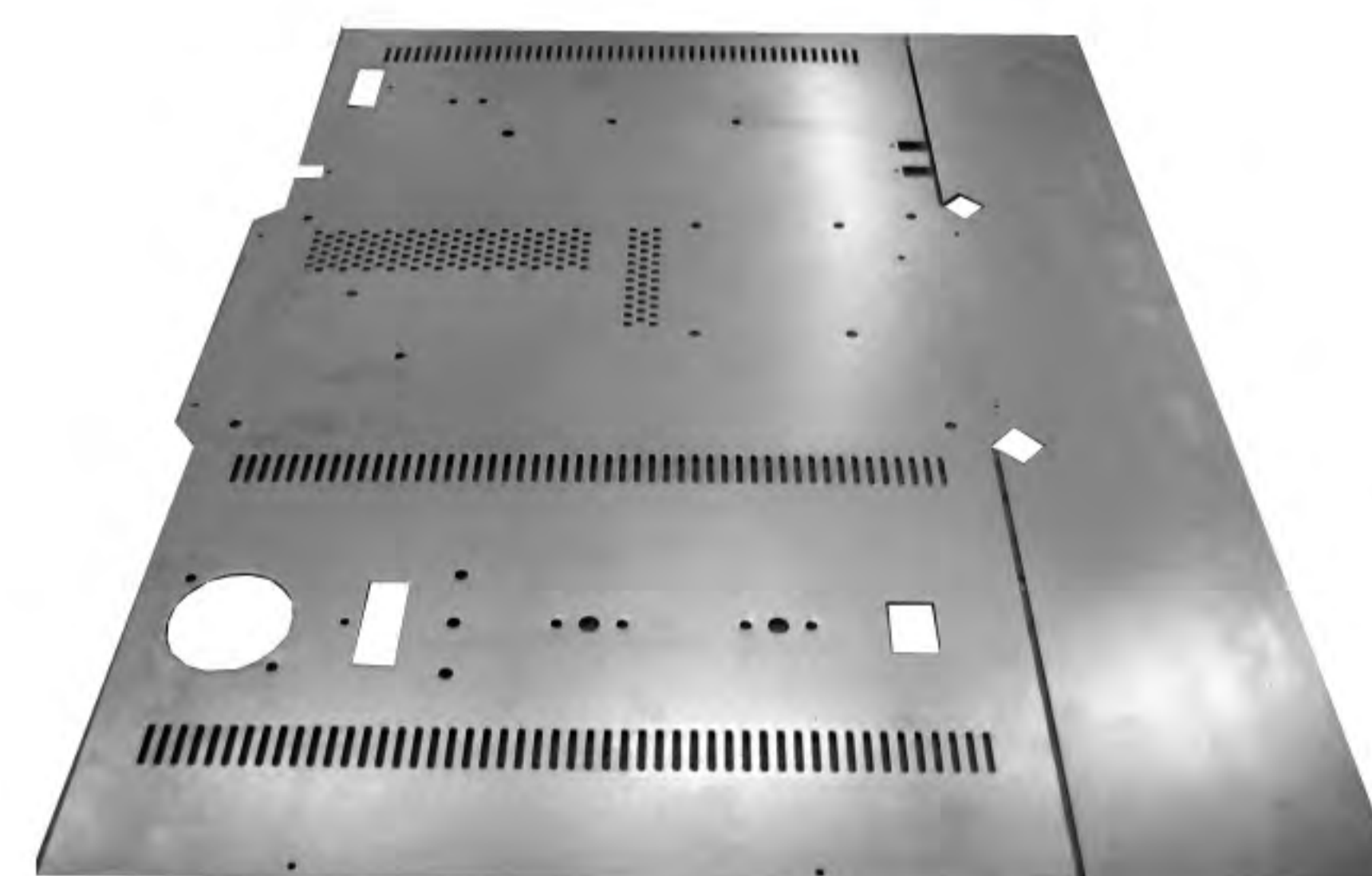

PROIZVODI PO ZAHTEVU
CUSTOM PRODUCTS

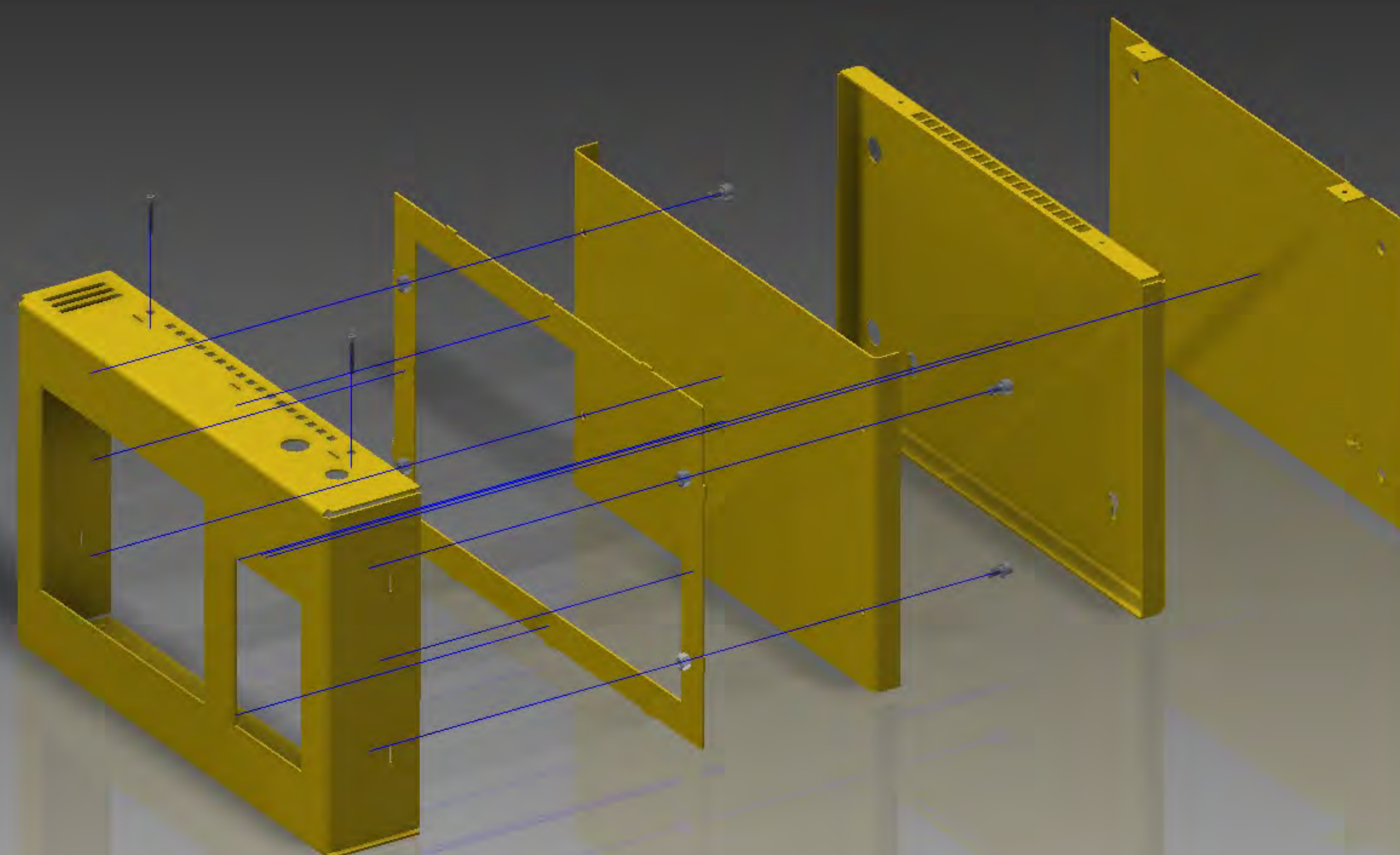

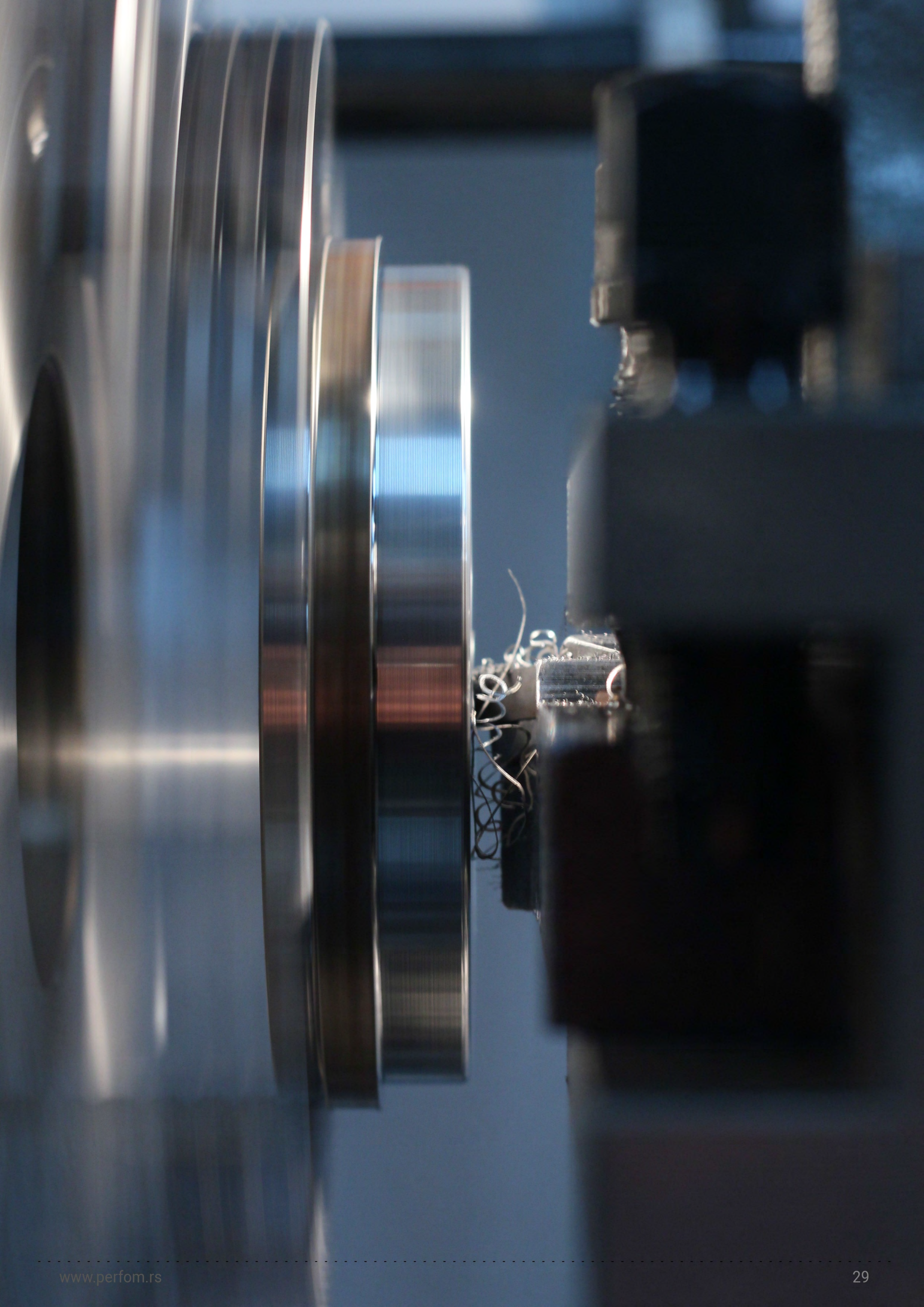

KONSTRUKCIJA ALATA I RAZVOJ PROIZVODA

TOOLING & PRODUCT DEVELOPMENT

- Dostavite nam crtež i uzorak proizvoda
- Konstruisaćemo i proizvesti sve potrebne alate
- Proizvedi ćemo za vas proizvode od lima metodom plastične deformacije
- Od ideje i uzorka do finalnog proizvoda sve u jednom preduzeću

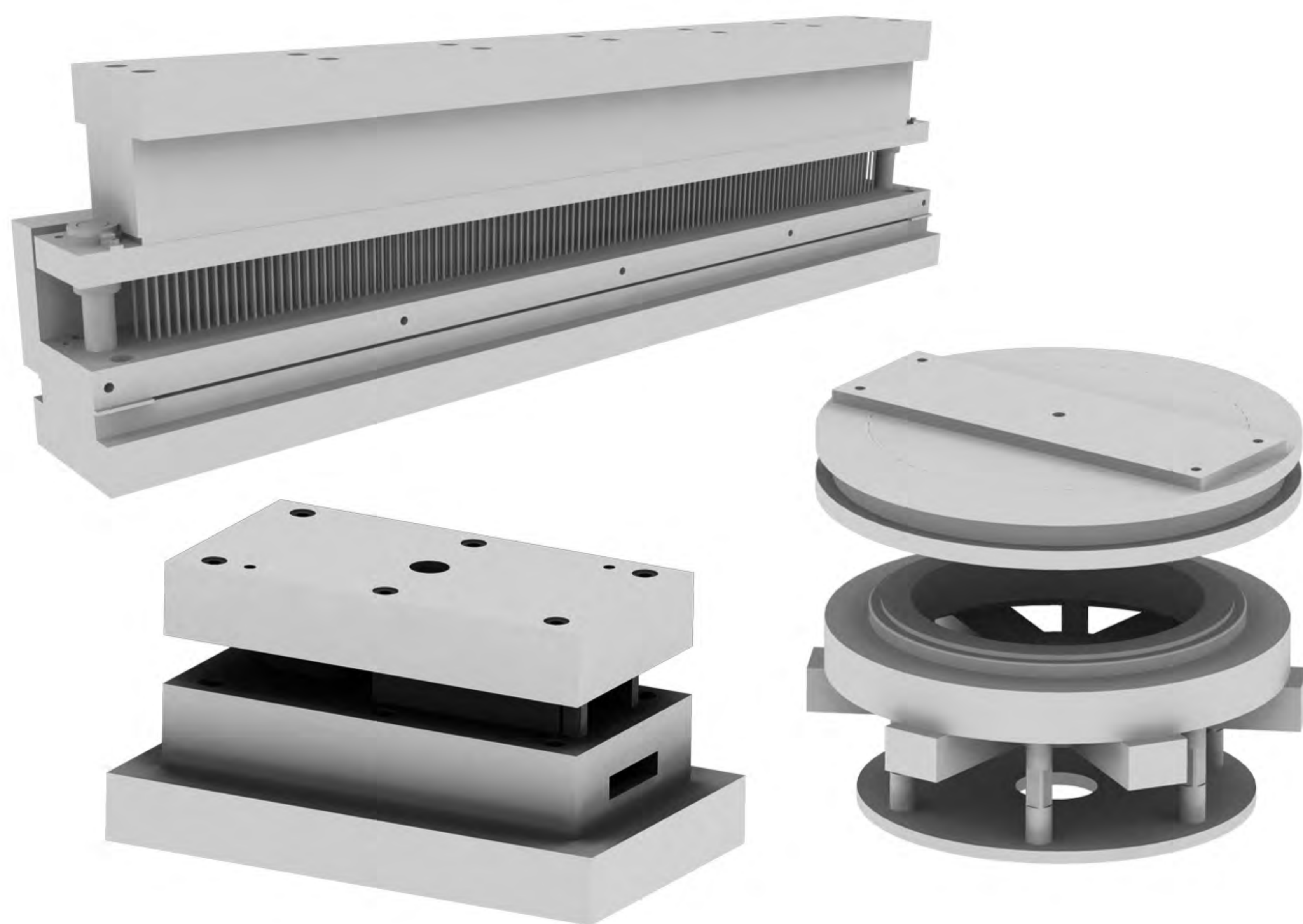

- Send to us drawings and samples
- We will design and made tools for production
- We will produce metal sheet products by PLASTIC deformation (punching, bending, surface trEatment...)
- From drawings and samples to final product all at one place

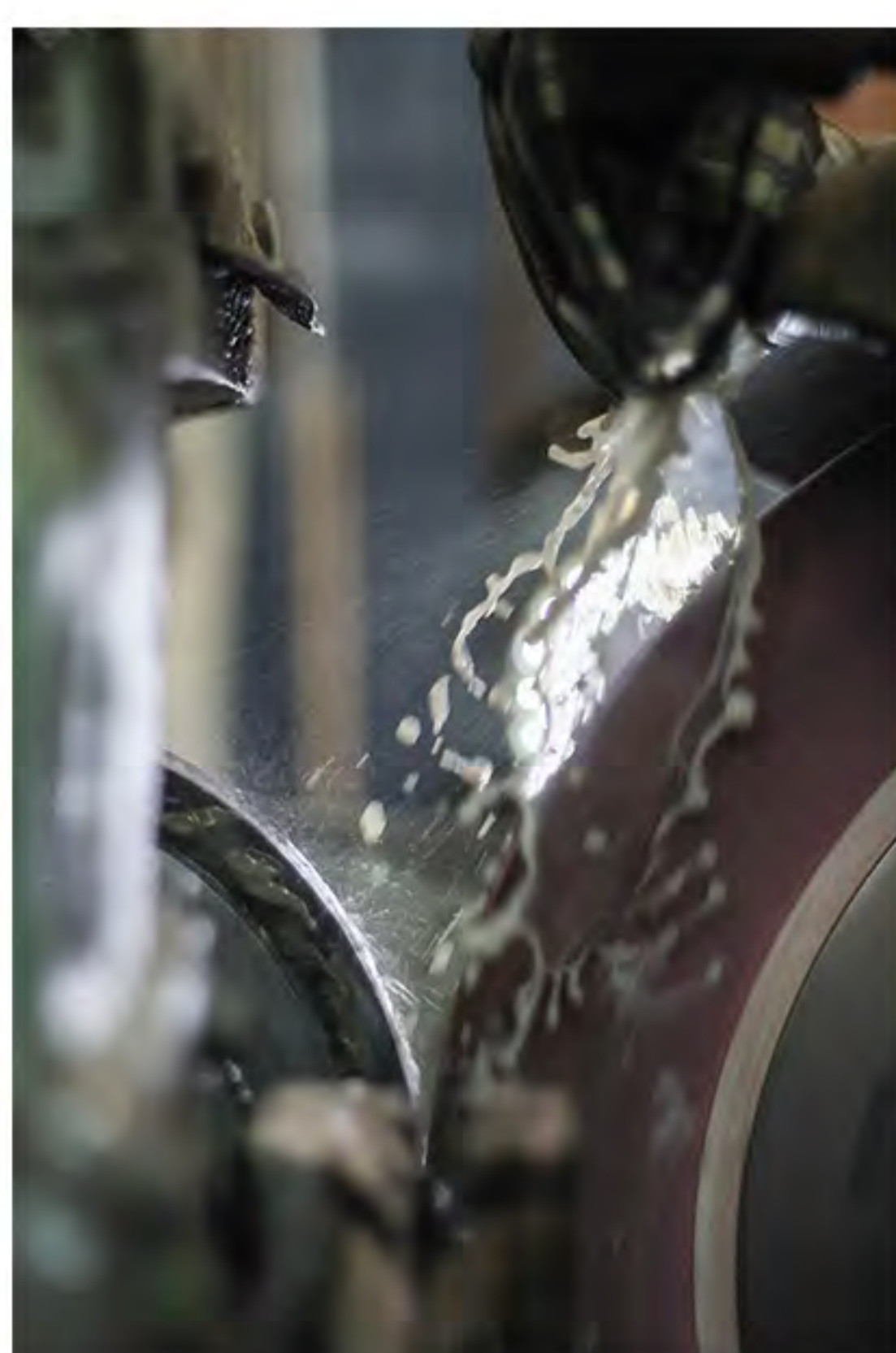
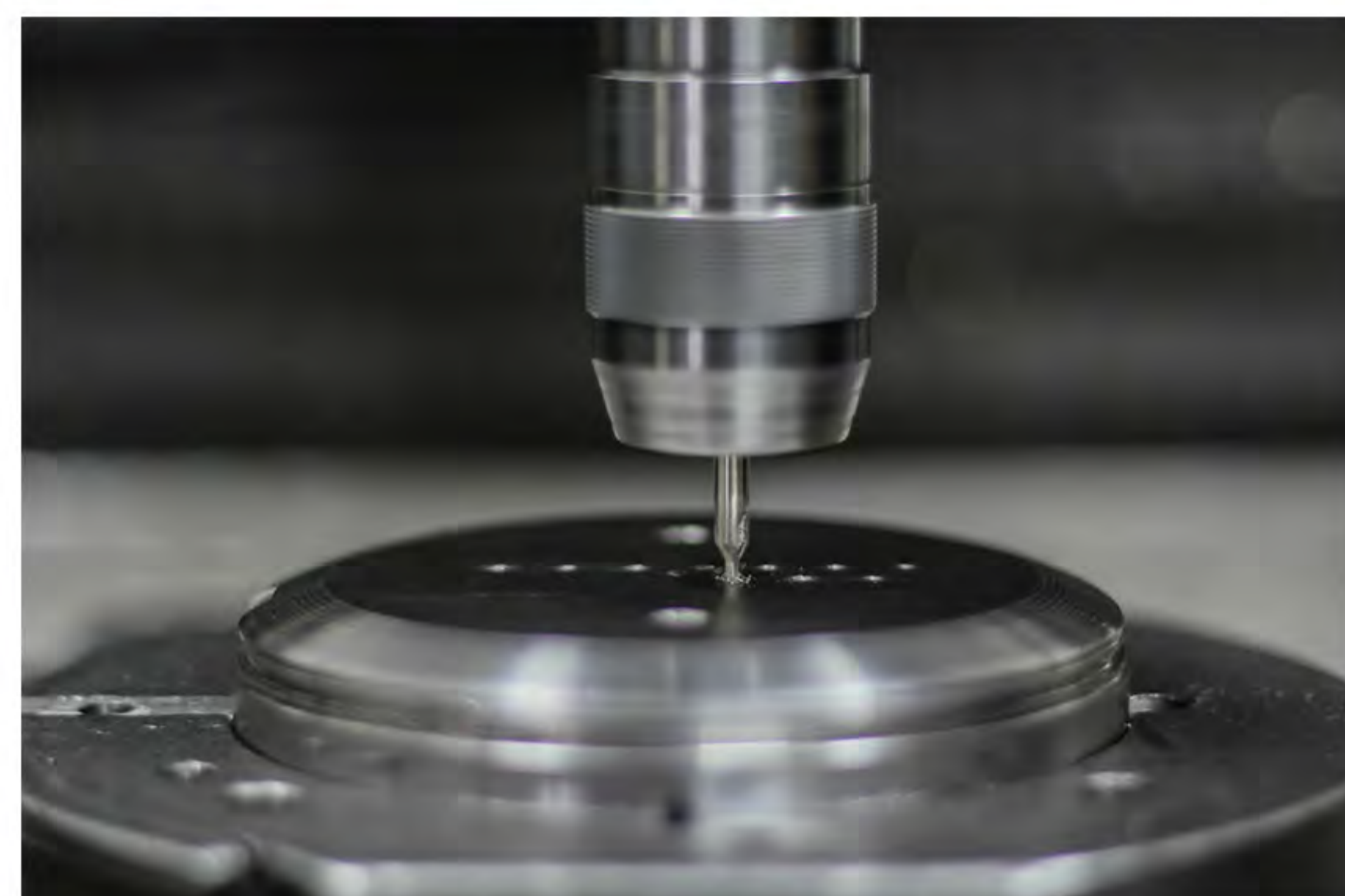

USLUGE SERVICES

NAŠE PROIZVODNE USLUGE:

- Perforacija (limova, plastike, gume, alubonda)
- Mehaničko peglanje limova
- Precizno isecanje
- Sečenje
- Savijanje
- Rolovanje (savijanje u krug - polukrug)
- Plastična deformacija materijala (prosecanje, probijanje, savijanje)
- Varenje *tig-mig
- Razvoj i proizvodnja probnih uzoraka i proizvoda po zahtevu

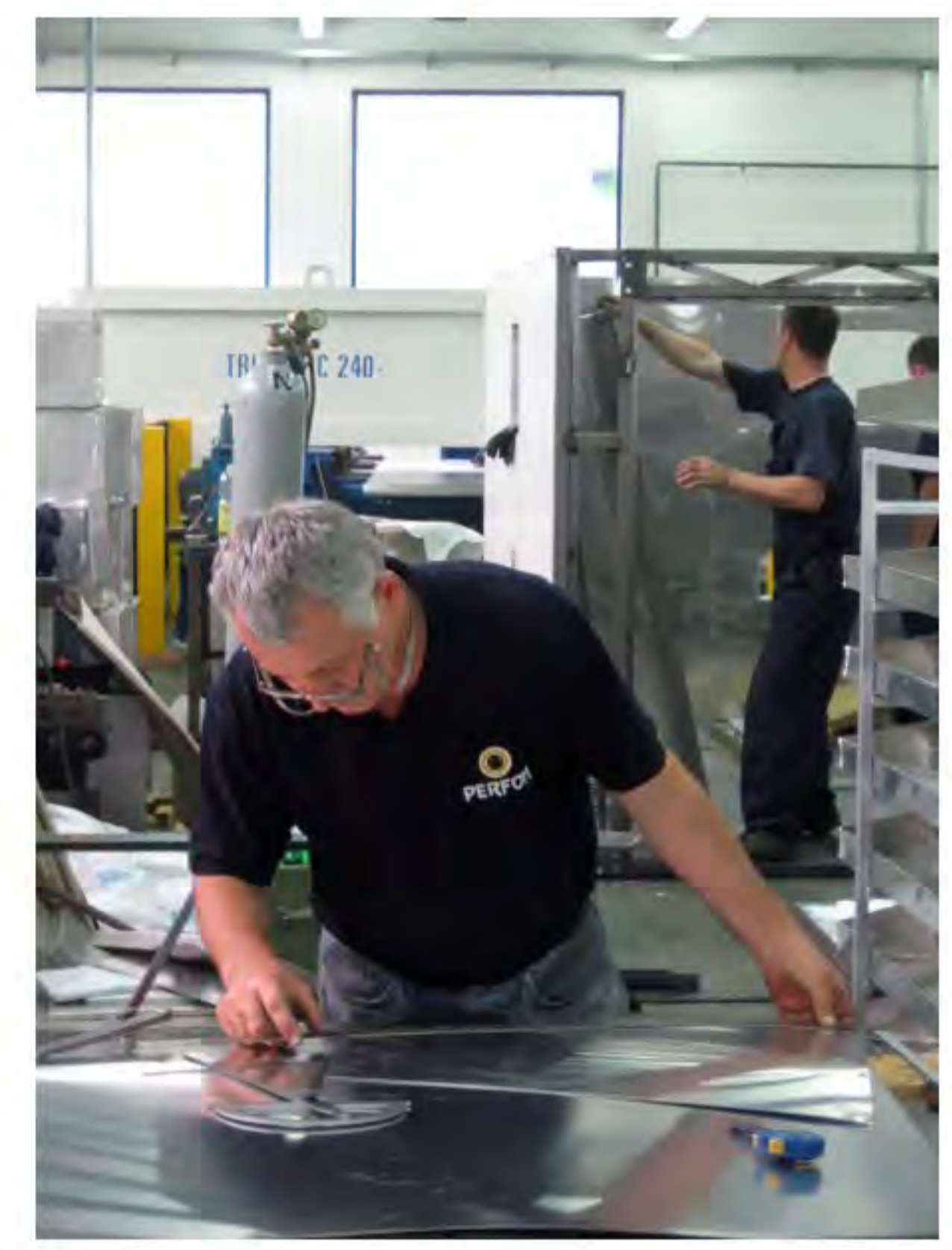

OUR PRODUCTION SERVICES:

- Perforation (sheet metal, plastic, rubber, alubond)
- Roll leveling
- Accurate notching
- Cutting
- Bending
- Rolling (Bending of the semi-circle)
- Metal forming (punching, bending, pressing parts)
- Welding *tig-mig
- Development and production of testing samples, prototypes and custom made products

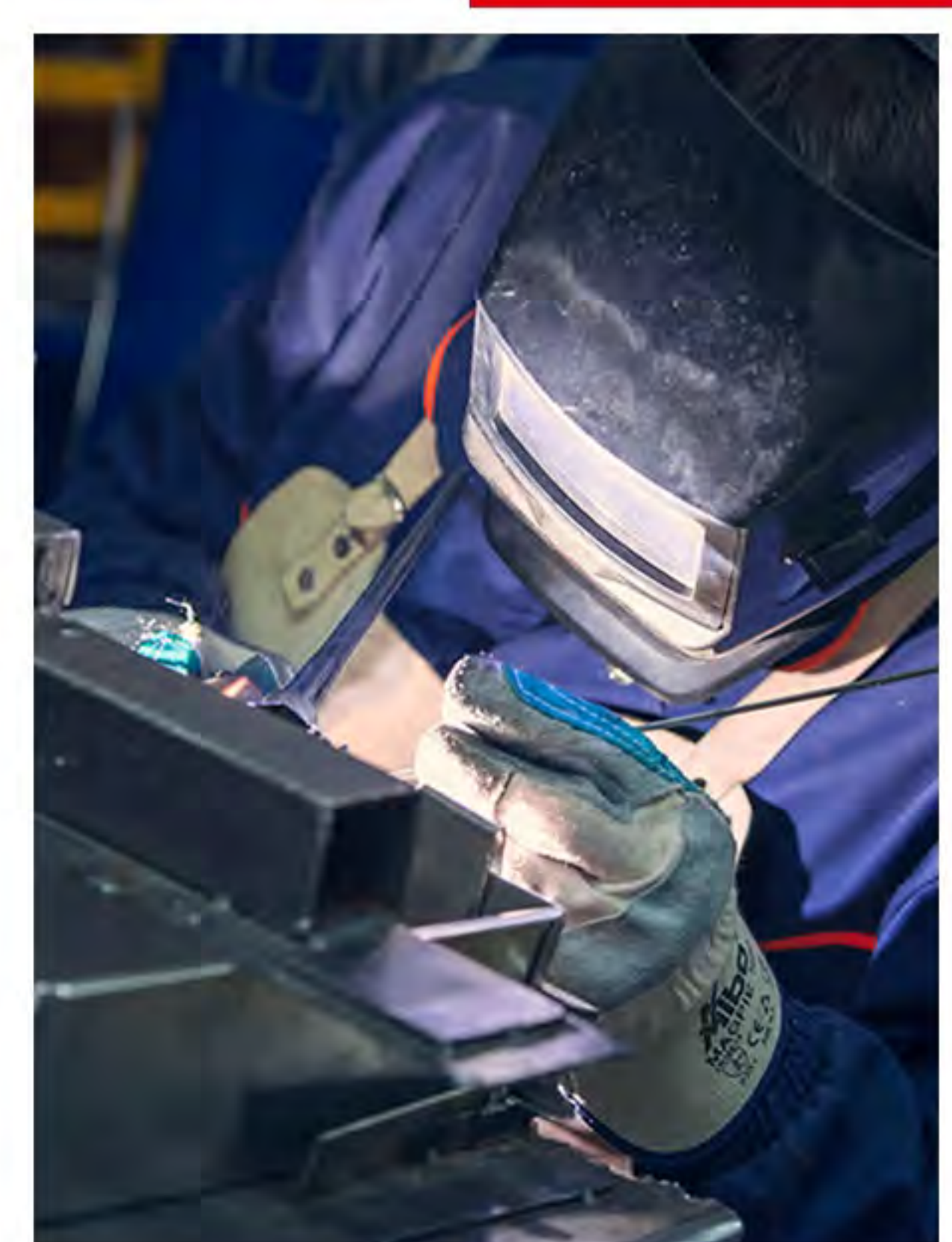



ZAŠTO IZABRATI PERFOM? WHY CHOOSE PERFOM?

- Mi smo porodična firma koja radi po načelima zdrave porodice;
- 70-to godišnje iskustvo i tradicija u obradi metala i limova;
- Koristimo modernu opremu i tehnologiju (CAD/CAM) u kombinaciji sa majstorskim zanjem i praksom;
- Vodimo računa i investiramo u edukaciju i razvoj zaposlenih;
- U radu i saradnji sa klijentima naši prioriteti su kvalitet, odgovornost i fleksibilnost;
- Proizvodimo male, srednje i velike serije, kao i prototipove po zahtevu kupca.

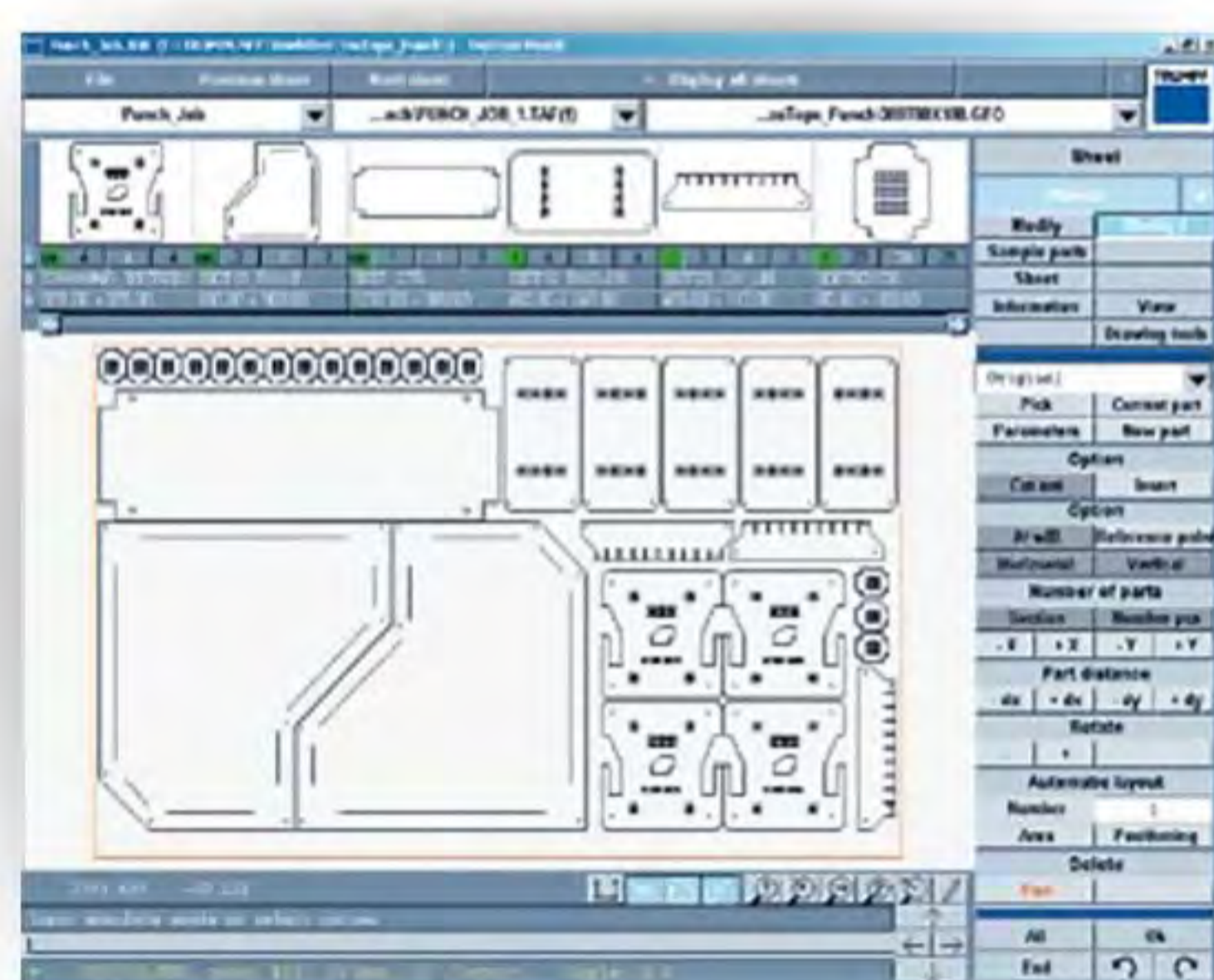

- We are small family owned and organized company.
- 70 years experience and tradition in metal forming and processing;
- We use modern technology (CAD/CAM) in production together with craftsman experience and knowledge;
- We take care of our employees and invest in their continuous professional development;
- We are driven by quality, responsibility and flexibility in production and cooperation;
- We have capacity to satisfy client needs for small and medium size series, to large production needs.

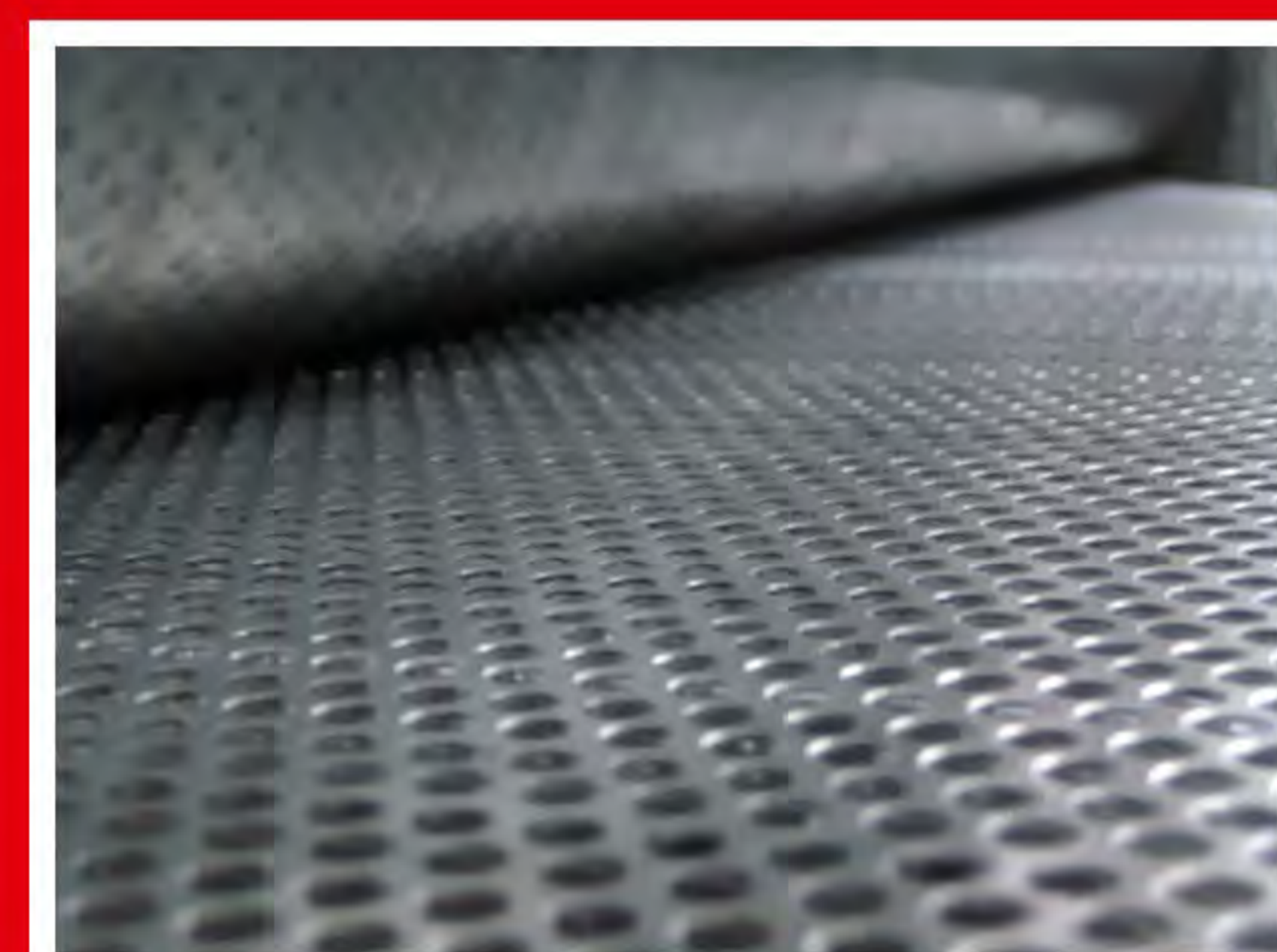

IDEJE I PRIMENA

IDEAS AND APPLICATION

- Audio i svetlosna tehnika
- Bela tehnika i elektronika
- Eksterijer i enterijer
- Javne površine
- Nameštaj
- Ograde i maske
- Pekarska industrija
- Poljoprivreda
- Prodavnice i radni prostor
- Protivklizna gazišta
- Radijatorske maske
- Industrija i mašinogradnja

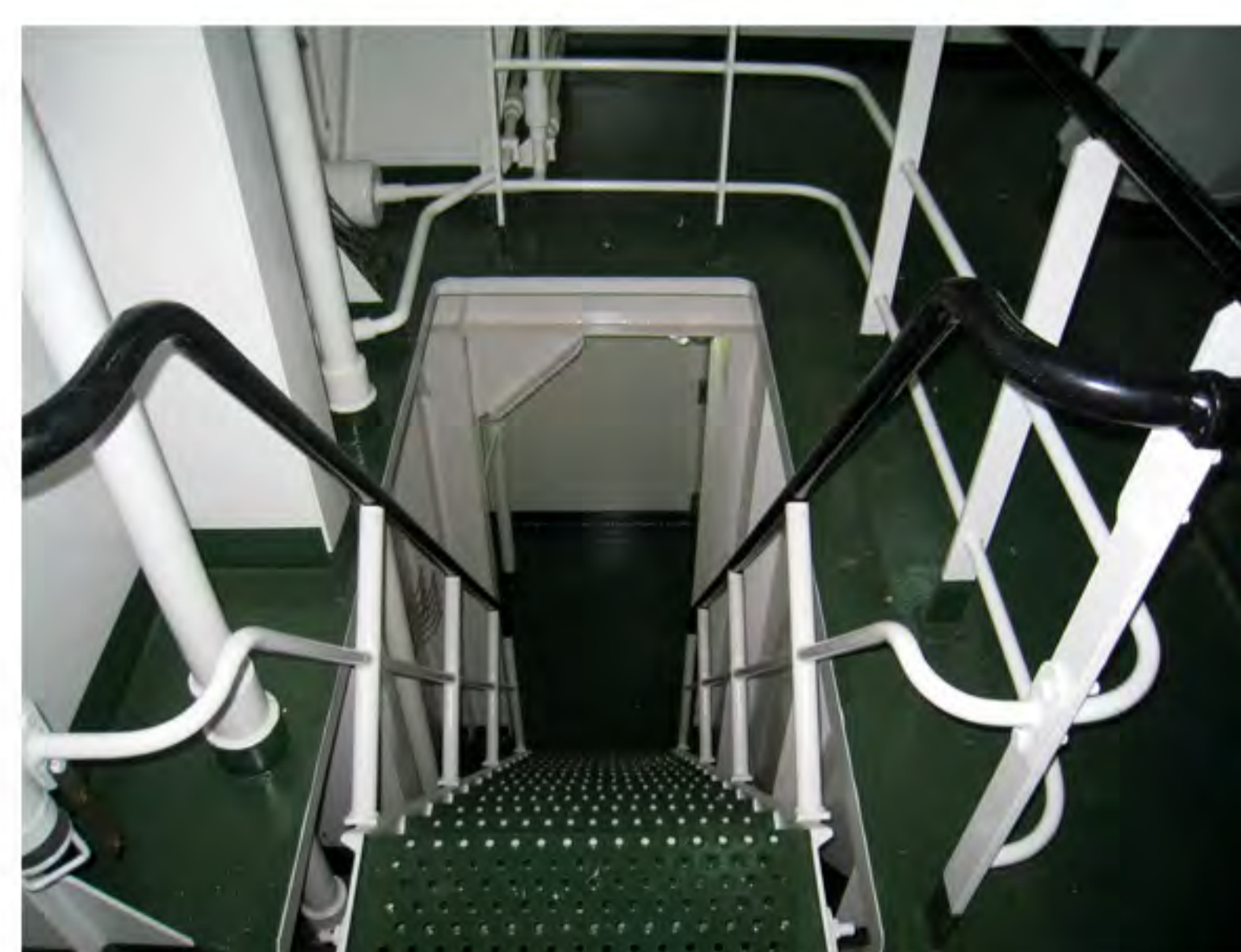
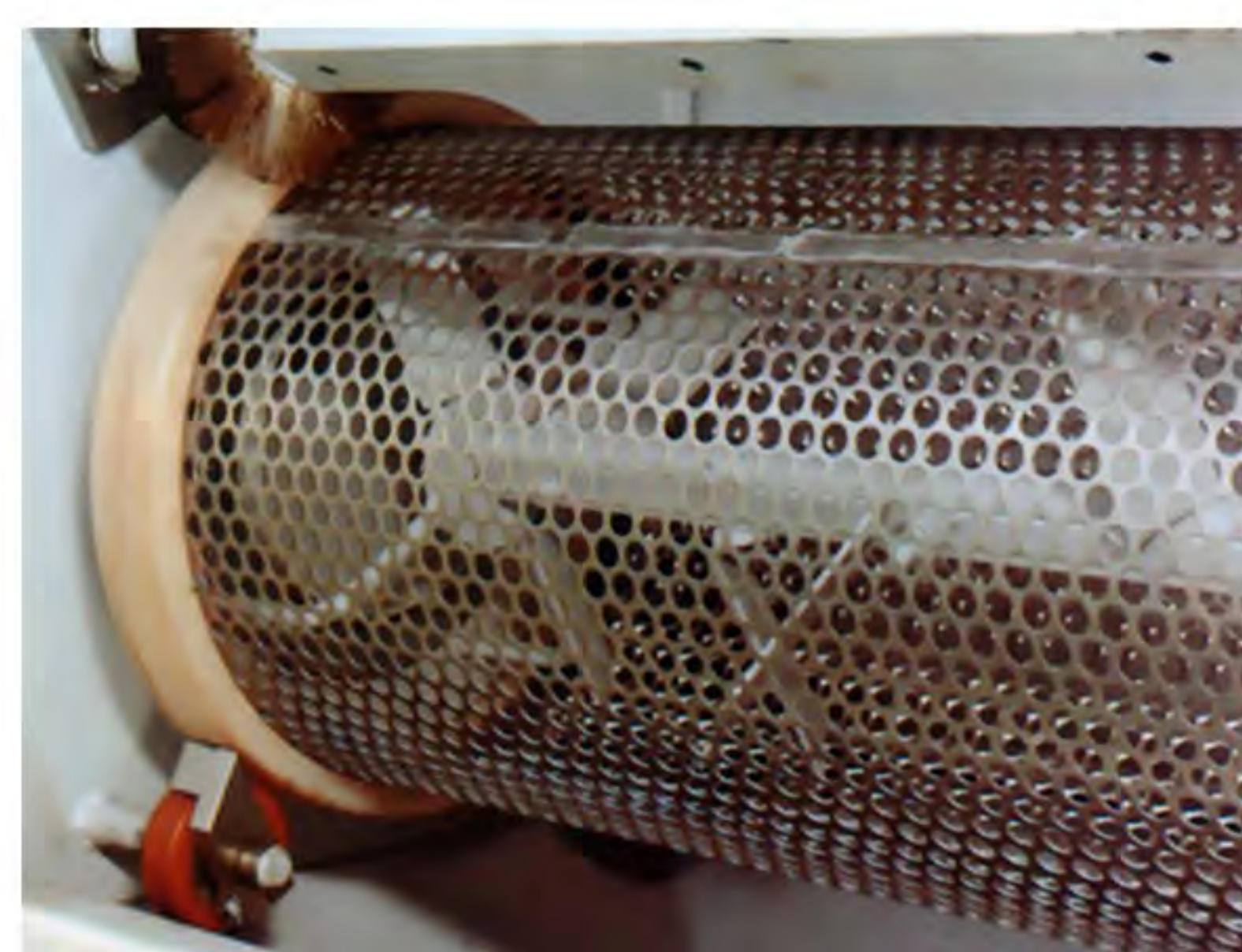

- Audio & lighting
- Household appliances
- Exterior & interior
- Public areas
- Furniture
- Fences & masks
- Baking industry
- Agriculture
- Stores & work spaces
- Antiskid gratings
- Radiator covers
- Industry & machine building

SEDIŠTE POŽEGA
COMPANY HEADQUARTER - POŽEGA

Perfom d.o.o.
Knjaza Miloša 165
31210 Požega, Srbija (Serbia)

Tel/fax:

+381 31 825 051
+381 31 714 380
+381 31 3816 656

Mobtel - komercijala /sales/:

+381 65 825 0514
+381 65 825 0515
+381 64 612 9305

Finansije i računovodstvo:

+381 31 715 755



Bonitetna izvrsnost

© Soliditet

e-mail:

prodaja /sale/
prodaja@perfom.rs
milivoje@perfom.rs
dragan@perfom.rs

direktor /CEO/
office@perfom.rs

web:
www.perfom.rs



ISO 14001



OHS 18001



ISO 9001